



**JUSTICE DEPT. WACO REPORT:  
Government Whitewash Continues**

# **SOLDIER OF FORTUNE**

FEBRUARY 1994  
# 48493

**SOF PROWL  
ATLANTIC ABOARD  
FAST-ATTACK  
SUBMARINE**

**EXPECT NO MERCY  
15 Months In  
Serb Captivity**

**PENTAGON  
WORDGAMES:  
Somali Vets  
Shafted By  
Military  
Bureaucracy**

**PLUS**  
• SAS Takes Down  
Terrorist Base  
• Russian One-Shot  
"Flame Thrower"  
• And Much More ...

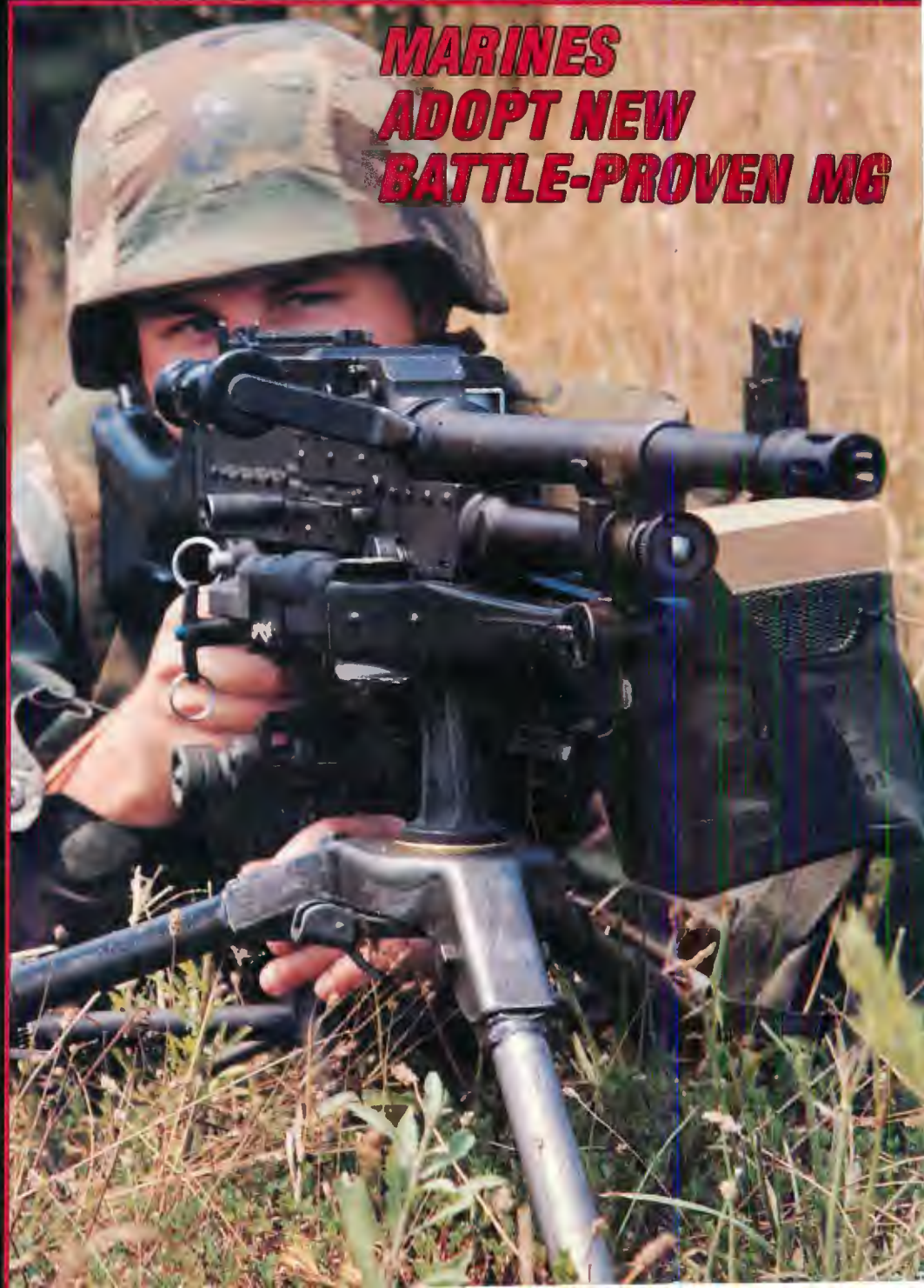

**MARINES  
ADOPT NEW  
BATTLE-PROVEN MG**



CAN. \$4.75 • UK £2.60 • U.S. \$3.95

# SOLDIER OF FORTUNE MAGAZINE

## RACING TO THE NEWSSTAND?



## SUBSCRIBE TODAY!

- 1 yr Subscription \$24.95
- 2 yr Subscription \$47.90
- Payment Enclosed (U.S. Funds only)
- MasterCard  Visa
- Exp. Date \_\_\_\_\_



Card# \_\_\_\_\_

Signature \_\_\_\_\_

NAME \_\_\_\_\_

ADDRESS \_\_\_\_\_

CITY \_\_\_\_\_ STATE \_\_\_\_\_ ZIP \_\_\_\_\_

DAY PHONE (     ) \_\_\_\_\_

EVE PHONE (     ) \_\_\_\_\_

**BNW294**

• Payment must accompany order. Offer good in the U.S. and possessions including APO, FPO addresses, for a limited time only. Canada add \$10.00 per year, (includes GST #R128476249) foreign add \$21.00/yr. Allow 6-8 weeks for delivery of first issue.

### COL. BROWN'S IRONCLAD GUARANTEE

If for any reason you're dissatisfied, cancel your subscription, and we'll refund the unused balance, no questions asked, period.

# Professional Locksmithing Tools

## LOCKAID

Specifically designed to pick tumbler locks. Designed over thirty years ago to aid law enforcement agencies. Consists of tension wrench, three needles and Lockaid "Gun." Prices include a copy of the book "Lock Picking Simplified."

Lockaid **\$69.95**



## PIX MODEL 13

This deluxe yet compact kit features 11 of the most commonly used tools. Comes in a slim cowhide leather case for discreet undercover operatives. As a special bonus, a 5 piece set of **warded picks is included**. A 18 piece set total. Also included, a copy of "Lockpicking Simplified." Receive all this at a Low price of:

Pix 13 **\$42.95**



## PXP 8

- Shirt Pocket Size.
- Top Grain Cowhide Leather.
- Has 8 Picks, Tension Wrenches and Broken Key Extractor.
- All Picks with Metal Handles.
- Copy of Lockpicking Simplified.

PXP 8 **\$24.95**

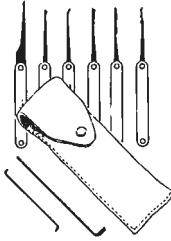

## PXP 10

- Shirt Pocket Size.
- Top Grain Cowhide Leather.
- Has 13 Picks, Tension Wrenches and Broken Key Extractor.
- All Picks with Metal Handles.
- Copy of Lockpicking Simplified.

PXP 10 **\$34.95**

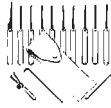

## PIX-EZ All-In-One Pick-Set

100% American Made! As convenient to carry and use as a pocket knife! Only 4 inches long, half inch square, weighs under five ounces, works fast and opens pin and waster tumbler locks quickly, with very little effort. Six tempered spring steel picks, tension wrench.

**\$34.95**



## WKS PICKS

Made of the finest blue tempered spring steel this 5 piece padlock pick-set is a must in every locksmiths' tool box. This set will pick open most every warded padlock made today.

**\$9.95**



## NEW MONTHLY SPECIAL

RECEIVE A COMBINATION SET  
INCLUDES — 5 ITEMS

1-MD-16 DELUXE SET .....	\$59.95
1-SCHALGE WAFER SET .....	\$27.95
1-SESAMEE DECODER .....	\$17.95
1-WKS PICKS .....	\$ 9.95
1-DOUBLE SIDED TUMBLER PICKS .....	\$27.95

A VALUE OF \$143.75

AT A LOW PRICE OF **\$89.95**

Lockpicking Simplified	\$8.50
Complete Guide to Lockpicking	\$15.00
Improvvised Lock Picks	\$9.95
Tubular Locks	\$8.95
Lockout and forced entry	\$8.95
Involuntary Repression	\$10.95

Safe & Vault manipulation	\$9.95
How to Pick Pins & Wafers	\$9.95
Combination Locks	\$8.50
Keys by Impressioning	\$7.00
Key Casting Manual	\$8.95
Locks, Picks, Clicks	\$10.00



## ESP-13

This handy new pick set is the most popular set among professional locksmiths today. This kit consists of 12 different tools housed in a handsome black leather case designed for a shirt pocket. Included in the price, you receive a 5 piece warded key set and a copy of "Lockpicking Simplified." 17 piece set total.

ESP-13 **\$45.95**



## KEY RING PICK SET



This unique design is ideal when low profile is required or to keep on your keyring for emergencies. Contains a tension wrench, three picks and the "Key Pick."

Key Ring Pick Set **\$27.95**

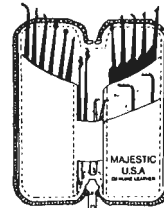

## MD16

Shirt Pocket Size, Top Grain Cowhide Leather, Zippered Case, has 16 Picks, Tension Wrenches and Broken Key Extractor.

**\$59.95**



## DOUBLE SIDED DISK TUMBLER PICKS

Set of 4 picks designed to be used on the most popular double-sided disc tumbler, showcase, cam and padlocks.

**\$27.95**



## MINI PICK TUBULAR

The most effective tubular pick on the market, unlike the larger picks with long handles or screwdriver handles. The longer the tool, the more pressure needed which causes easy breakage. The advantage of the Mini Pick is it is so short, you only use your thumb and index finger. With a little practice this tool will open a tubular lock in less than a minute.

**\$69.95**

## SESAMEE DECODER

This tool was designed to decode the exact combination of a sesame padlock without damaging the lock. Detailed instruction included.



**\$17.95**

## SCHLAGE WAFER

The most fantastic tool you will ever use. This set consists of two base keys and pick. Complete instructions included.

**\$27.95**

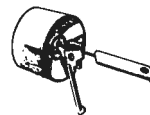

## MD32

Hip Pocket Size, Top Grain Cowhide Leather, Zippered Case, has 32 picks, Tension Wrenches, Broken Key Extractor.

**\$69.95**

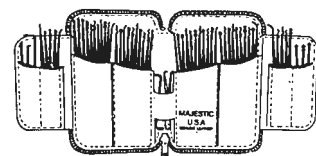
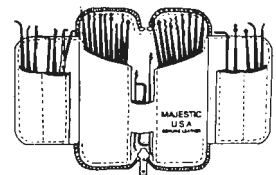

## MD60

Top Grain Cowhide Leather, Zippered Case, has 60 picks, Tension Wrenches, Broken Key Extractor and Warded Master Keys.

**\$89.95**

Orders over \$100  
Free Shipping  
Catalog \$2.00  
Free with order.  
Sorry, no credit card orders



The law requires all purchases be made in good faith, without make believe or fraud by genuine persons within this industry

Send to  
**Steve Arnolds  
Gun Room**  
postage & handling \$4.00  
Overseas Surface \$6.00

Add 20% of total for overseas mail. Must be 18 years of age.

P.O. Box 68, Dept. SF02, Dexter, OR 97431; (503) 726-6360

# COMMAND GUIDANCE

## U.S. POWs Were Transferred To Soviets

by Alex McColl

### MAGAZINE STAFF

**Editor/Publisher** ..... Robert K. Brown  
**Associate Publisher** .... T. (Lefty) Wilson  
**Executive Editor** ..... Tom Slizewski  
**Senior Editor** ..... Don McLean  
**Technical Editor** ..... Peter G. Kokalis  
**Associate Editor** ..... Jerry Park  
**Assistant Editor** ..... Lynne Robertson  
**Production Director** ..... Kathleen Allard  
**Art Director** ..... Mary Scrimgeour Jenkins  
**Design Associate** ..... Krissie Anderson

### Foreign Correspondents

**Chief Foreign Correspondent** ..... Dr. Tom Marks  
**Senior Foreign Correspondents:**  
Steve Salisbury • Rob Krott • Peter Douglas •  
Chuck Fremont • Morgan Tanner •  
Jack Thompson • Major Mike Williams •  
Mike Winchester • Dale B. Cooper

### Contributing Editors

*Vietnam Veterans Affairs* Col. Chuck Allen •  
*Military History* William Brooks — William H.  
Northacker • *Unconventional Operations* Brig.  
Gen. Heine Aderholt — James P. Monaghan  
— Maj. Robert MacKenzie • *Military Affairs*  
Alexander McColl • *Paramedic Operations*  
Dr. John Peters • *Explosives/Demolitions* John  
Donovan • *Aviation* Dana Drenkowski • *Africa*  
Al Venter • *Outdoor Affairs* Galen Geer • *Latin*  
*America* Hugo Hartenstein • *Battle Blades* Greg  
Walker • *Gun Rights* Paul Danish • *Skydiving*  
Kitty Baran

### Business Manager

**& Controller** ..... Sharon Windsor  
**Bookkeeper/**  
**Classified Advertising** ... Carole Hayden  
**Circulation Manager** ..... Carrie Karlson  
**Consultant** ..... Zada Johnson  
**Advertising Manager/Assistant**  
**Convention Director** ..... Dianne McLeod  
**Receptionist** ..... Helena Oberg

For editorial/advertising, call 303-449-3750.  
Subscription inquiries, call 1-800-877-5207  
For list rental contact: Dave Power, Antigone  
Associates 215-357-9267

### In Memoriam

Craig Nunn — Art Director  
Lance Motley — Foreign Correspondent  
Barry Sadler — Contributing Editor

NOTICE: SOLDIER OF FORTUNE Magazine is a magazine of national and international distribution. There may be products in the magazine of which sale, possession or interstate transportation may be restricted, prohibited or subject to special licensing requirements in your state. Purchasers should consult local law enforcement authorities in their area. All data in this publication, technical or otherwise, is based upon personal experience or individuals using specific tools, products, equipment and components under particular conditions and circumstances, some of which may not be reported in the article and which Soldier Of Fortune has not otherwise verified. Soldier Of Fortune, its agents, officers and employees disclaim any responsibility for all liability, injuries or damages.

*Soldier Of Fortune* recently obtained a copy of a document prepared by the Joint Commission Support Branch (JCSB), Research and Analysis Division, (under the assistant secretary of defense for POW/MIA affairs) titled *The Transfer of U.S. Korean War POWs to the Soviet Union*. The JCSB is the Washington-based analytic, translational and administrative element of the U.S. side of a U.S.-Russian joint commission on POW/MIAs.

The first sentence of the executive summary sets out a shocking fact that is thoroughly documented by the rest of the study: "U.S. Korean War POWs were transferred to the Soviet Union and never repatriated." Transferring POWs to a third country is a violation of the generally agreed upon laws of war; and not returning them after the end of hostilities is a much worse violation. What became of these men in the Soviet Union is not stated.

Apparently the present and former officers of the Soviet/Russian army, including the GRU (Soviet military intelligence) have been at least cautiously cooperative. The KGB and its predecessor, the MGB, have been much less cooperative, apparently for two reasons: First, a general detestation for Americans, whom they blame for the downfall of the USSR and their own loss of power. Secondly, as this document reveals, after their initial receipt and interrogation by the Soviet military, the U.S. POWs were handed over to the MGB for further exploitation and eventual disposition. Now the writers of this document are cautious in drawing inferences from the facts presented and this gives all the more weight to the last sentence of the summary:

"From the other side of the dark curtain, the new Soviet leadership [Stalin's successors] might well have had the same fears and consigned the POWs in their hands to oblivion."

The KGB is obviously not eager to admit to and provide details of the

probable disposition of surviving American, South Korean and other POWs in their hands.

At this period the Chinese and North Koreans were entirely subservient to the Soviets and did as they were told, including, as a matter of policy, turning over captured aircrew members to the Soviets. There were, apparently, two major objectives to the program of taking selected U.S. POWs to the USSR:

Firstly, intelligence exploitation, especially in the area of aircraft technologies. The manifest superiority of the F-86 Sabre over the MiG-15 resulted in a massive effort to recover intact F-86 aircraft and pilots (they eventually got three aircraft). At one time the Soviets had no less than 70 teams committed to this project. The report lists by name 31 Sabre pilots who might have been captured but were never repatriated; strong indications surfaced that three of these men were in fact held by the Soviets and at least two were taken to Soviet design bureaus near Moscow to help with the technical exploitation of recovered F-86s. The Soviets were also very much interested in B-29 and RB-45C aircrews. Secondly, as the report states, "It is possible that Stalin, given his positive experience with Axis POWs, viewed U.S. POWs as potentially lucrative hostages."

A Soviet General Staff-based analytical group was assigned to and conducted extensive interrogations of U.S. and other POWs at Khabarovsk, the hub of the interrogation effort and temporary holding and transshipment point for U.S. POWs at the time. The MGB controlled these prisoners from here on, but allowed the GRU to interrogate them. No prisoners relating such an experience have been repatriated. The source for this is retired Colonel Gavriil Korotkov, who participated in the operation.

In addition to the relatively small numbers of F-86 pilots and other

*Continued on page 26*

SOLDIER OF FORTUNE (ISSN 0145-6784/USPS 52810) is published monthly by SOLDIER OF FORTUNE Magazine Inc., 5735 Arapahoe Ave., Boulder, Colorado 80303-1340. Second Class Postage Paid at Boulder, CO. POSTMASTER: Send address changes to SOLDIER OF FORTUNE, Subscription Department, P.O. Box 348, Mt. Morris, IL 61054-0348, or call 1-800-877-5207. U.S. and APO-FPO subscription rates for twelve monthly issues: \$28.00. California residents add 7.25% tax. Canada add \$10.00/yr. additional postage (includes GST tax registration number: R128476249). All other countries add \$21.00. U.S. FUNDS ONLY. Single Issue Price — U.S., \$3.95; United Kingdom, £2.60; Canada, \$4.75. PRINTED IN THE U.S.A.

CONTRIBUTORS: Manuscripts, photographs or drawings are submitted at the contributor's own risk. Material should be mailed to Articles Editor, SOLDIER OF FORTUNE, P.O. Box 693, Boulder, CO 80306, and cannot be returned unless accompanied by sufficient postage. Any material accepted is subject to such revision as is necessary to meet the editorial requirements of SOF. All manuscripts must be typed double-spaced. All photographs should be credited and be accurately identified. Payment will be made at rates current at time of publication. Editorial office phone number is 303-449-3750.

Copyright © 1994 by SOLDIER OF FORTUNE Magazine Inc. All Rights Reserved.

## FEATURES



Waco Whitewash – page 56

Photo: CBS News

**SEMPER MAG** ..... Peter G. Kokalis  
The few, the proud, the well-equipped? U.S. Marine Corps chooses a battle-proven Belgian classic to replace the much-maligned M60 GPMG – check out the M240G ..... 30

**BEST LITTLE WAR-HOUSE** ..... Robert MacKenzie  
SPLAT Arena and Simunition combine for professional, ultra-realistic training at a price anyone can afford – you use your own firearm and hits hurt ..... 36

**WORLD-CLASS THUNDER RANCH** ..... Bill Burris  
Clint Smith's 2,400-acre Texas shooters' paradise is in a league of its own and may set the standard of excellence for live-fire workouts into the next century ..... 38

**EXPECT NO MERCY** ..... Robin Anthony  
Released Croat prisoner lays bare the brutal beatings, torture and starvation of POWs under Serbian captivity; a startling account of '90s-style barbarism ..... 40

**JUST CAUSE** ..... James L. Pate  
Lawyers band together to fight for conservative and constitutional issues. There's not much money to be made in this type of lawyering, but the Cause Foundation puts principle ahead of profit ..... 43

**FAST STRIKE ON CHIMOIO II** ..... Robert MacKenzie  
Heavily outnumbered Rhodesian strike force takes down terrorist sanctuary in Mozambique. A firsthand account from an SAS troop commander who helped make it happen ..... 44



Thunder Ranch – page 38

Photo: courtesy Thunder Ranch

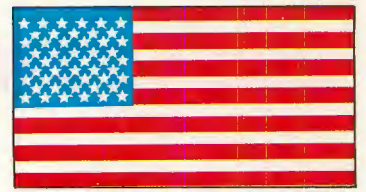

**COLUMNS**



Run Silent – page 48

Photo: Dale B. Cooper

**RUN SILENT, RUN DEEP** ..... Dale B. Cooper  
SOF goes on board with the submariners who prowls undersea in our Navy's fast-attack nuclear boats – a breed apart, these specialists operate in a shadowy world of radar blips and sonar pings ..... 48

**PENTAGON WORDGAMES** ..... John Zimmerman & Greg Walker  
When is combat really combat? Who decides when grunts who prevail in Third World firefights merit honors? Two combat vets probe the baffling maze of U.S. military doublespeak..... 54

**GOVERNMENT'S WACO WHITEWASH CONTINUES** ..... James L. Pate  
SOF examines the Justice Department's report on the Waco tragedy, an official vindication of their own lethal end to a standoff where innocents were sacrificed ..... 56

**DISPOSABLE HEAT** ..... SOF Staff  
Russia's rarely seen shoulder-fired RPO, or "rocket, infantry, flame thrower," is disposable/reloadable and suited for multiple uses – proof that Eastern arms are still evolving in spite of serious economic and political problems ..... 62

**Bulletin Board** ..... 6  
One More Thirty Years' War?

**Slick Willie Watch** ..... 10

**FLAK** ..... 15  
Gotta Get Down And Dirty

**Full Auto** ..... 20  
Camp Carbine Conversions

**World SitRep** ..... 22

**Combat Weaponcraft** ..... 24  
Marksmanship & Magic Bullets

**Second Amendment OP** ..... 29  
Now's The Time

**Supply Locker** ..... 72

**Classified** ..... 77

**Advertisers Index** ..... 82



**COVER**

After struggling more than a quarter-century with the gravely flawed M60 GPMG, the U.S. Marine Corps has adopted the .30-caliber M240G, a ground version of FN's M240 coaxial tank machine gun. For once, U.S. taxpayers get excellent value for their money. See story on page 30. Photo: Peter G. Kokalis

# BULLETIN BOARD

## EDITORIAL LEAP FORWARD

The cover blurb on the December '93 issue of *SOF* touting "ATF Tries to Hide Waco Investigation Files" did not match an article inside on that topic. After the December cover was finished, we had a (rare) opportunity to move the article in question ahead to the November issue, and did so because of its timeliness. It ran under the title "Waco: The Fix Is On?" in the Command Guidance column. We regret any confusion this may have caused.



Spoiled of war: a Brit company named Battlefield Archaeology is now engaged in locating, digging and, where necessary, deactivating ordnance, weapons and effluvia from European battlefields. These battlefield remains are then mounted with placards explaining what the item is, where it was found and any historical significance. If you want to decorate your den with findings from WW I or WW II, contact them at Box 421, Dept. SOF, Newcastle-under-Lyme, Staffordshire ST5 0QJ, UK. Photo: courtesy Battlefield Archaeology

## LEATHERNECK UNHOOKED FROM TAILHOOK

The Marine Corps has dismissed charges against Captain Gregory J. Bonham for "conduct unbecoming an officer" during the 1991 Tailhook Association convention in Las Vegas. He was accused of putting his hand inside the bra of Navy Lieutenant Paula Coughlin. Court martials are still pending against three Navy officers in the incident.

## EQUAL SEATING

Once the Pentagon opened the skies to female pilots last spring, it was soon discovered that nearly half the fly gals would be too small to safely fit cockpits of the new trainers. Engineers have made design alterations, but find that designing a cockpit which will accommodate the smallest woman and the largest man is close to impossible. Latest redesigns will accommodate 80% of potential female pilots and 95% of male pilots, but the Senate Armed Services Committee wants to bar purchase of the new trainer

until it will accommodate 95% of both male and female pilot candidates. Commented Elaine Donnelly, a member of last year's presidential commission on women in combat, "The primary consideration should be crew safety and the needs of the Air Force, not the needs of a theoretical few."



Look familiar? Part of Firebase Delta, a quarter-of-a-million-dollar scale model of the real thing, built by Timothy R. Thompson of Lake City, Florida, as a memorial to his father. Benjamin A. Thompson was declared MIA in the Vietnam War, and was last seen at this firebase in the Mekong Delta. Built over a 10-year period, the memorial has been donated by Thompson to the Lake City VA Medical Hospital. Photo: courtesy Timothy R. Thompson

In a related development, *Jane's Defence Weekly* reports that a proposed new ejection seat for the U.S. Joint Primary Air Training System (JPATS) program will use "smart" rocket propellant cartridges to cope with the variation in weight between male and female aircrew ... from a "generalized subject" weight of 42 kg to an upper limit of 111 kg.

## CARIBBEAN INVADED BY U-BOATERS

In March 1994 Sharkhunters, the world's only multinational submarine history group, will embark on a Caribbean cruise through the waters where German U-boats found such good hunting during World War II. On board as guest lecturers will be some of the top German U-boat skippers, in addition to American and Russian submarine veterans.

If interested in joining this group of former enemies gathering as friends on the high seas, get the full details from Sharkhunters, Box 1539, Hernando, FL 34442; phone 904-637-2917; fax: 904-637-6289.

## HARD CURRENCY SPEAKS?

We eavesdropped from an impeccable source that a U.S.-based anticommunist Vietnamese expatriate group has rented the studio and broadcast facilities of the former Soviet World Service, and is beaming anticommunist programs to Vietnam from Moscow. Heh, heh. Now *that's* a creative use of Cold War surplus. In the former Soviet Union these days, it's: if it moves, salute it; if it doesn't move, sell it for hard currency; if it's too big to move, rent it.



# PALADIN PRESS

## FUGITIVE

### How to Run, Hide, and Survive

by Kenn Abaygo

If you're serious about going on the lam, this book may be the most valuable asset you've ever laid your hands on. It may just save your life. In it, author Kenn Abaygo, a U.S. government reconnaissance and intelligence-gathering specialist with years of professional evasion experience worldwide, guides you through the mountains, forests, deserts, swamps and plains like a shadow on the darkest night. You'll learn to build an "invisible" evasion shelter, erect path guards that divert a potential intruder without his even knowing it, "lose" a pack of tracking dogs, enter the "Network" of people willing to assist evaders, apply natural camouflage and utilize primitive first aid skills and medicinal herbalism in the wilderness. This unique manual sinks into the unknown and exposes you to possibilities you never even considered. Having read it, you'll have what it takes to disappear off the face of the earth - and stay there for as long as you need to. 5 1/2 x 8 1/2, softcover, 96 pp. **\$12.00**

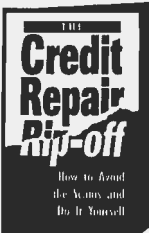
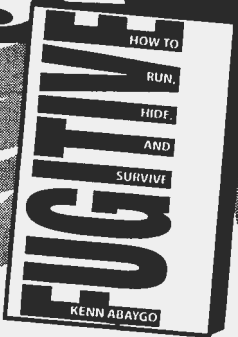

**THE CREDIT REPAIR RIP-OFF**  
How to Avoid the Scams and Do It Yourself  
by Bob Hammond

Many people in financial distress have been lured by advertisements implying that bad credit can be magically erased, only to end up deeper in debt than ever. This exposé is Bob Hammond's attempt to put an end to that by revealing the truth about the credit repair scams and empowering consumers to help themselves. 5 1/2 x 8 1/2, softcover, 208 pp. **\$16.00**

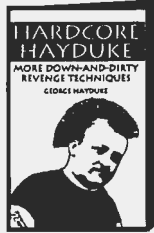

**HARDCORE HAYDUKE**  
More Down-and-Dirty Revenge Techniques  
by George Hayduke

Just when you thought bullies were once again getting the upper hand in this mean old world, George Hayduke and his legions of fans return with more clever, devious and downright nasty tricks, pranks and campaigns to turn "marks" into sniveling fear freaks! For entertainment purposes only! 5 1/2 x 8 1/2, hardcover, 240 pp. **\$19.95**



**COMBAT RACEGUNS**  
The World's Best Custom Pistols  
by J.M. Ramos

Combat raceguns - customized pistols for competition and carry - shoot faster, stay on target longer, hold more ammo and are more accurate than out-of-the-box handguns. This book will show you how to put together your own precision pistol using the best custom compensators and accessories available today. 8 1/2 x 11, softcover, photos, illus., 168 pp. **\$25.00**



**BOOK II - HOW TO GET ANYTHING ON ANYBODY**  
The Encyclopedia of Personal Surveillance  
by Lee Lapin

This long-awaited follow-up to the best-selling first volume is a gold mine of the latest techniques and tricks of intelligence collection. Learn how to bypass computer passwords, look or listen through solid walls, gather personal data on anyone and much more! 8 1/2 x 11, softcover, photos, illus., 232 pp. **\$35.00**



**ULTIMATE SNIPER: THE VIDEO**  
w/ John Plaster & Carlos Hathcock  
Learn the art of sniping from two masters. Maj. John Plaster instructs you in all areas of sniping fieldcraft, marksmanship and tactics, and famed USMC sniper Carlos Hathcock recounts some of the field-tested tactics he used to rack up 93 confirmed kills in Vietnam. Covers optics, weapons, shooting drills, camo, stalking, hides, countersniping, range and wind estimation and more. Color, approx. 90 min., VHS only. **\$59.95**



**THE ULTIMATE SNIPER**  
An Advanced Training Manual for Military and Police Snipers  
by Maj. John L. Plaster, USAR (Ret.)

This highly readable and extremely valuable training book covers the practical, field-tested details of sniping's three great skill areas - marksmanship, fieldcraft and tactics. Rifles, scopes, ballistics, target detection, stalking, hides, camo, countersniping, special ops, police vs. military and much more. 8 1/2 x 11, softcover, photos, illus. 464 pp. **\$39.95**

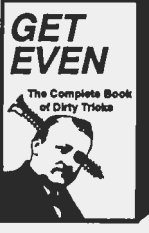

**GET EVEN**  
The Complete Book of Dirty Tricks  
by George Hayduke

A hilarious overview of the methods people use to get even with big business, government and enemies. These dirty tricks range from the simple to the elaborate, including more sophisticated schemes devised by CIA and Mafia members and political dirty tricksters. For entertainment only. 5 1/2 x 8 1/2, hardcover, 208 pp. **\$19.95**



**HOW TO GET ANYTHING ON ANYBODY**  
by Lee Lapin

Get the goods on others with this encyclopedia of advanced investigative and surveillance techniques. Here are expert ways to secretly bug any target! Info on lock-pick technology, how polygraphs and voice lie detectors can be tricked and much more, including more than 100 sources for spy equipment. 8 1/2 x 11, softcover, illus., 272 pp. **\$30.00**



**SEAL SNIPER TRAINING PROGRAM**

This highly sought manual - until now available only to this elite cadre of specially trained SEALs - contains the complete program by which SEAL snipers train, equip and operate. Included are precise instructions and exclusive, clear photos for target sighting, aiming, trigger control, aircraft takedown, range estimation, helo insertion, ship boarding, stalking, marksmanship and more. 8 1/2 x 11, softcover, photos, illus. 320 pp. **\$30.00**



**LICENSE TO STEAL**  
Traveling Con Artists: Their Game, Their Rules - Your Money  
by Dennis Marlock & John Dowling

This is an in-depth study of the Gypsy Mafia, the criminal element of the Romani population. Through police files, newspapers, historical data and interviews with victims, the authors expose the truth about this highly organized multibillion dollar business and tell you how to protect your money from con artists of all kinds. 5 1/2 x 8 1/2, hardcover, 304 pp. **\$30.00**



**SOE SECRET OPERATIONS MANUAL**  
Never before released to the public, this is the original manual used to train special agents dropped behind enemy lines in Nazi-occupied Europe. Used by the British SOE and its American counterpart, the OSS, it is an authentic reproduction of extraordinary historical significance obtained from a former clandestine services operative. The forerunner of all government guides to dirty tricks. 5 1/2 x 8 1/2, softcover, 272 pp. **\$20.00**



**SKINHEAD STREET GANGS**  
by Loren Christensen

This is a crash course in racist violence by Loren Christensen, a nationally recognized expert on skinhead gangs and police officer in Portland, Oregon, a city once dubbed the "Skinhead Capital of the U.S." This cop's view of skinheads explains who they are, why they're violent, who their targets are, how they operate, what weapons they favor and what danger they pose to society and to police. 5 1/2 x 8 1/2, softcover, photos, illus., 240 pp. **\$20.00**

## OTHER FASCINATING TITLES

- BOOK 2: HOW TO GET ANYTHING ON ANYBODY .....\$35.00
- HOW TO BECOME A MASTER HANDGUNNER.....\$10.00
- CREDIT SECRETS: HOW TO ERASE BAD CREDIT.....\$14.00
- SEAL/SNIPER TRAINING PROGRAM.....\$30.00
- U.S. NAVY SEAL COMBAT MANUAL.....\$19.95
- MINI-14: THE PLUNKER, HUNTER, ASSAULT, AND EVERYTHING ELSE RIFLE...\$12.00
- COMPLETE AR-15/M16 SOURCEBOOK.....\$35.00

- GET EVEN 2: MORE DIRTY TRICKS FROM THE MASTER OF REVENGE.....\$19.95
- HANDGUN STOPPING POWER: THE DEFINITIVE STUDY.....\$39.95
- MAKING YOUR AR-15 INTO A LEGAL PISTOL.....\$14.00
- AK47: THE COMPLETE KALASHNIKOV FAMILY OF ASSAULT RIFLES.....\$14.00
- AMBUSH! NAVY SEALS IN DEADLY ACTION (VIDEO)....\$29.95
- HANDGUN MUZZLE FLASH TESTS: HOW POLICE CARTRIDGES COMPARE.....\$20.00

### MONEY-BACK GUARANTEE — DEALER INQUIRIES INVITED

Paladin Press • P.O. Box 1307 • Boulder, CO 80306 • (303)443-7250  
FAX (303)442-8741

Videotapes are nonreturnable. Damaged tapes will be replaced.



**PALADIN PRESS**  
P.O. BOX 1307-ABS  
BOULDER, CO 80306



**CREDIT CARD ORDERS CALL TOLL FREE**

1-800-835-2246, EXT. 21

Call 24 hours a day, 7 days a week. Send \$2.00 for a 56 page CATALOG of over 500 titles (free with order).

PLEASE SEND ME THE FOLLOWING TITLES:

\_\_\_\_\_

\_\_\_\_\_

\_\_\_\_\_

\_\_\_\_\_

VISA  MASTERCARD  CHECK / MONEY ORDER

CARD# \_\_\_\_\_

EXP. \_\_\_\_\_

NAME \_\_\_\_\_

SUBTOTAL \_\_\_\_\_

ADDRESS \_\_\_\_\_

CITY \_\_\_\_\_

PLEASE INCLUDE POSTAGE & HANDLING \$ 4.00

STATE \_\_\_\_\_ ZIP \_\_\_\_\_

TOTAL \_\_\_\_\_



## SOF WACO COVERAGE ON SHOOTIN' SHOW

*The Shootin' Show*, which has been running segments on *SOF* and the *SOF* Convention is now also on the The Outdoor Channel. Satellite coordinates are F-2, Channel 3, and *The Shootin' Show* will be running Saturday (2200 EST), Sunday (1800 EST), Tuesday (1600 EST) and Wednesday (1700 EST).

In addition, watch *The Shootin' Show* for weekly coverage of the Waco trials, featuring on-site reports from *SOF* correspondent Jim Pate, as soon as jury selection and other details are resolved, probably sometime in February.

## MODERN REVISIONIST HISTORY

Communist commissars, Hitler apologists and others noted for rewriting history to suit their own peculiar views of the world could only regard *1992 FBI Shooting Incidents* with admiration and envy. "This information is not to be the subject of any press release," states a warning on the annual

publication, prepared by Special Agent Gregg D. Gilliland of the Firearms Training Unit at the FBI Academy in Quantico, Virginia.

Under the geographic heading of Salt Lake City, the bureau's regional office closest to Naples, Idaho — where Vicki Weaver was shot through the head by Special Agent Lon Horiuchi — herewith follows the *entire* incident report:

*At approximately 6:00 p.m., agents were positioning themselves around the residence where a subject who was previously involved in the killing of a U.S. Marshall [sic] was living. The subject's family and friend were located in the house. The agents were positioning themselves so they could order the subject and other occupants in the residence to surrender. While the agents were in place, they noticed individuals armed with shoulder weapons exit the residence and move to a different building. At this time a FBI helicopter was flying over the area and the subjects appeared to be preparing to fire at the helicopter. One of the agents*

*(a sniper) fired at the subjects to stop them from shooting at the helicopter. The subjects then ran back toward the residence and the agent fired another shot at the subjects. One subject was killed and two were wounded. One subject gave himself up immediately and one gave up several days later.*

First, FBI agents were in position — but had not revealed their presence or offered anyone in the Weaver cabin the chance to surrender. They issued a shoot-to-kill order — an illegal order — for anyone coming out of the cabin with a weapon. Second, the "subject," Randy Weaver had nothing to do with the killing of the U.S. Marshal. Third, the yarn about the helicopter was a lie; the pilot testified he was nowhere near when the FBI sniper opened fire. No one on Ruby Ridge raised a firearm in that incident — except the agent who killed an innocent mother with babe in arms. And no one surrendered "immediately." Kevin Harris, nearly dead, gave up several days later, and Weaver after that. — James L. Pate ✕

Paul Vunak's

## The JKD STREET FIGHTING SERIES

Progressive Fighting Systems — Jeet Kune Do

### Tape #1: JKD's Straight Blast

"... whenever Bruce was really serious about a fight, he'd always revert back to the straight blast."  
DAN INOSANTO

### Tape #2: Dumog (Filipino Wrestling)

A man who truly understands Dumog can throw a 250 lb. person across the room.

### Tape #3: Head Butts, Knees and Elbows

This is absolutely Vunak's most vicious tape yet.

### Tape #4: JKD's Energy Drills

These drills are the foundation of JKD... a *MUST* for people who are serious about trapping.

VHS Tapes #1 – #4 sell for \$54.95 each (includes s & h)

**Buy the Whole Set One \$219.80** (includes s & h),  
and you'll receive Paul's "ATTRIBUTES II" video  
— A Tribute To Bruce Lee — absolutely FREE!

All tapes are available in VHS or VHS/PAL format. VHS/PAL tapes are \$10 more per tape (includes s & h). C.O.D. Extra.  
Send Check or Money Order to: (PA residents include 6% sales tax.)

**PFS Video - SF • P.O. Box 50, Oley, PA 19547**

For information on seminars and instruction by Paul Vunak, call (310) 439-3089.

For Dealer/Distributor Information, or seminar information call (215) 689-5871 or FAX (215) 689-4027.

Paul teaches hand-to-hand and knife fighting to the Navy Seal Teams, Marines, Air Force and other specialized units.

### Tape #5: Pananjakman (Rapid Fire Kicking)

The Filipino art of low line nerve destruction.

### Tape #6: Advanced Knife Fighting

"This is the best knife fighting tape I've seen to date."  
GREG WALKER, Editor of Fighting Knives Magazine  
This tape shows the realities of the knife.

### Tape #7: Advanced Trapping

Paul is considered "world class" at his trapping skills.

### Tape #8: Mass Attack

This tape shows Paul in real life scenarios, fighting all out!

## ATTRIBUTES II

A Tribute to Bruce Lee

Approximate Running Time: 30 minutes

\$34.95 (includes s & h)

VHS Tapes #5 – #8 sell for \$64.95 each (includes s & h)

**Buy the Whole Set Two \$239.80** (includes s & h),  
**AND SAVE \$20.00!**



# Read about the weapon that makes men **SHIVER**

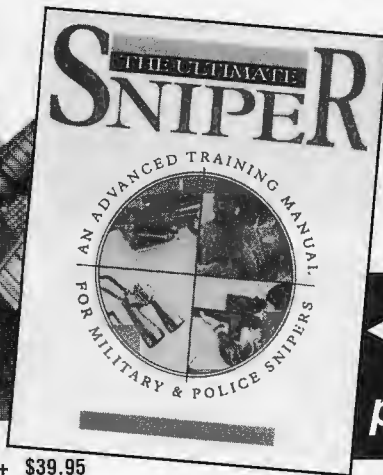

He's been feared throughout history—an invisible, distant foe who's cool, selective and unerring. Read all about the procedures used by today's snipers. Read it **FREE** when you join *The Military Book Club*®!

◀ Get this book **FREE** plus **3** more for **98¢** when you join

- |  |   |   |   |   |   |  |   |   |   |   |
|--|---|---|---|---|---|--|---|---|---|---|
|    |    |    |    |    |   |   |    |   |   |   |
| 1594-9999* \$32.95   | 2915+ \$19.95   | 1768+ \$18.95   | 2949 \$22.00  | 6791+ \$14.95   | 3848 \$14.95  | 3947-9999* \$29.95   | 3269-9999* \$39.95  |   |   |   |
|   |   |   |   |   |   |   |   |   |   |   |
| 2931 \$24.95   | 1891 \$23.00  | 3012 \$12.95x   | 3335 \$19.95  | 1859 \$21.95  | 6437 \$24.95  | 3897 \$22.95   | 3301++ \$22.95  | 8029 \$20.00  | 3061 \$24.95  |   |
|  |  |  |  |  |  |  |  |  |  |  |
| 7708 \$24.95   | 5785 \$16.95x   | 7666 \$19.95  | 7955 \$17.95x   | 4069 \$14.95x   | 0349+ \$7.95x   | 1677 \$24.95   | 3053 \$22.95  | 3731 \$24.95  | 2923 \$19.95x   | 3715 \$35.00  |

## HERE'S WHAT YOU GET WHEN YOU JOIN...

**A GUARANTEE OF SATISFACTION.** Once your membership's accepted, we'll send your 3 BOOKS plus *THE ULTIMATE SNIPER*. If you're dissatisfied with them, return just the 3 books within 10 days at our expense. Membership will be canceled; you'll owe nothing.

**THE FREE CLUB MAGAZINE.** You'll receive up to 16 issues a year. Each reviews the Featured Book Selection(s) plus dozens of alternate books.

**SHOPPING MADE SIMPLE.** To get the Featured Book Selection(s), do nothing—it will be sent automatically. If you prefer another book—or none at all—simply return your Member Reply Form by the specified date. A shipping and handling charge (and sales tax, where applicable) is added to each order.

**HUGE DISCOUNTS ON HARDCOVER BOOKS.** Save as much as 30% off publishers' edition prices. Club books are sometimes altered in size to fit special presses.

**AN EASY-TO-MEET OBLIGATION.** Take up to 2 years to buy 4 more books at regular low Club prices. Afterwards, you may resign membership anytime.

**RISK-FREE RETURN PRIVILEGES.** If you get an unwanted book because your Club magazine was delayed and you had less than 10 days to respond, simply return the book at our expense.

Prices shown are for publishers' hardcover editions. Club hardcover editions save you up to 30%.

\*Counts as 2 choices x Special edition exclusively for Club members + Softcover ++Fiction

**THE MILITARY BOOK CLUB** ★★

**Your #1 Source for Military Books**

**YES!** Please enroll me in *The Military Book Club* according to the risk-free membership plan described in this ad. Send me *THE ULTIMATE SNIPER*, FREE, plus the 3 BOOKS I've indicated. Bill me just 98¢, plus shipping and handling.

**SAVE MORE—BUY YOUR FIRST BOOK NOW FOR \$3.99** (write book number)

Send me the book I've indicated and reduce my commitment to only 3 more books. Bill me an additional \$3.99, plus shipping and handling.

48035      73

Mr./Mrs. \_\_\_\_\_  
Miss/Ms. \_\_\_\_\_  
(please print)

Address \_\_\_\_\_ Apt. \_\_\_\_\_

City \_\_\_\_\_

State \_\_\_\_\_ Zip \_\_\_\_\_

Members accepted in U.S.A. and Canada only. Canadian members serviced from Canada, where offer is slightly different. Sales tax added where applicable. We reserve the right to reject any application. SOF 2/94

FREE BOOK #3871

48036      74

If you select a book that counts as 2 choices, write the first 4 digits of the book number in one row of boxes and 9999 in the next.

# SLICK WILLIE WATCH

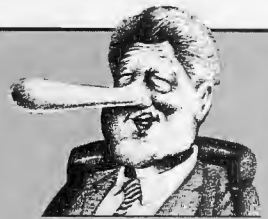

## CLINTON'S ARMY SECRETARY BUSTED (NEWS)

Acting Secretary of the Army John Shannon was busted for allegedly shoplifting a woman's blouse and skirt from the Ft. Meyer, Virginia, PX. Dropped as Army secretary, Shannon was rehired as a Pentagon consultant.

## ARKANSAS HOLIDAYS CANCELED (JOKE)

Halloween and Thanksgiving were not observed in Arkansas this year, as the witch went to Washington and took the turkey with her.

## FED-FUZZ QUIZ (SATIRE)

Not long ago, we'd have boxed the collective ears of those who thought the following was remotely funny. How times have changed. Now it's people within our

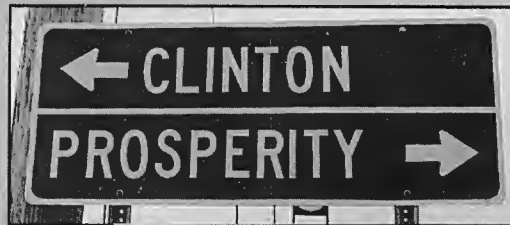

Destined to be the most-photographed sign in America, sent in by a Carolina reader.

government who deserve to get their ears boxed. The following semi-satirical Federal Agent quiz was sent in by Grigorii Elfemovich Rasputin of Texas:

Why was agent Lon Horiuchi, the sniper who shot and killed a woman with a baby in her arms on Ruby Ridge, censured by his boss? *His boss said anybody who can't hit a baby at that range has no business in the FBI.*

How many federal agents does it take to shoot a 14-year-old boy in

the back? *Only 50, but the element of surprise has to be on their side.*

How many FBI agents does it take to burn down a building and kill the 84 civilians inside? *Only 100, but it'll take them 51 days to figure out where best to torch a plywood building.*

What's the difference between the FBI and the PLO? *The PLO has renounced the use of terrorism and murder, and has agreed to pursue its political objectives through peaceful means.*

## FAVORITE BUMPER STICKER (NEWS)

*BILL'S RIGHTS, or BILL OF RIGHTS?* Available for 50 cents each from Wolfe Publishing, Dept. SOF, 6471 Airpark Drive, Prescott, AZ 86301.

# NIGHT VISION

## AN/PVS-2B

(GEN I)



The AN/PVS-2B mounted on M-16. (Rifle not included)

**\$1695.00**

Plus \$100 for weapon mount

## AN/PVS-4

(GEN II)



The AN/PVS-4 mounted on a Remington 788 rifle. (Rifle not included)

**\$3295.00**

New with excellent cond. intensifier

## NVEC 500 MINIATURE (GEN II) POCKETSCOPE with camera adapter!

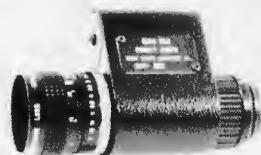

**\$3395.00**

Plus Shipping

## NIGHT VISION GOGGLES

New w/Factory New Image Intensifier (1 yr. wty.) Operates on "AA" batteries!



(GEN II)  
**NVEC 800**  
(AN/PVS-5C)  
**\$5850.00**

Plus Shipping



(GEN II)  
**AN/PVS-7B**  
**\$ 3850.00**

Plus Shipping

Night Vision goggles and viewers. Extensive parts inventory for both First and Second Generation Systems, plus reconditioning and general repair.

Send \$4 for our complete catalog  
**NO F.F.L. REQUIRED**  
COMPLETE LINE  
of individual & crew-served weaponsights.

## Excalibur Enterprises

P.O. Box 400, Fogelsville, PA 18051-0400  
ph: 215-391-9106 FAX: 215-391-9223

**DEALERS! INQUIRE ABOUT OUR SPECIAL PRICING PROGRAM**

**And the amazing thing is, you can learn it in just days!**

# **Secret New Fighting System Will Make Even A Black-Belt Karate Master Putty In Your Hands!**

**If You Are Even Remotely Interested In Learning How To Physically Protect Yourself (and your loved ones) *With 100% Certainty*, Then This Will Be The Most Important Letter You Ever Read.**

Very few people will ever be allowed to see the material presented here – I am being almost ridiculously selective because of the incredibly *dangerous potential* of the information revealed.

– by: *Leo Costa, Jr.* –

Dear Friend,

**Here is why:** I have recently discovered a "scientific" fighting system that is so effective, you will be able to *knock senseless* anyone who confronts you – no matter how skilled they are at fighting – within **1 or 2 seconds!** What's more, this fighting system is so easy to learn, you will be able to *master* it quickly and completely, even if you have never been in a fight before in your life, or are a "klutz" at physical skills. Kids, women, even grandparents can master this system with equal ease – and be able to instantly "put away" any bully or criminal who comes after them.

This system is called **Hostile Control Systems** (or "HCS" for short). I've seen it in action, I've used it, and I tell you with all seriousness that it is simply...

## **The Most Devastating Fighting System Imaginable – Yet It's Like Nothing You've Seen Before!**

In most cases, you'll be able to end a fight instantly with a *single move* no matter how "overmatched" you are in size or meanness. You do not need quick reflexes, big muscles, flexibility, or any previous fighting skills at all. Nor do you need months or years of practice, because you can learn *everything* – on your own – in an astonishingly short time – a matter of days! And since this amazing new system is based on the way you move *naturally*, once you see how HCS works, you'll know instinctively how to use it *forever!*

I know you're probably skeptical right now – I certainly was at first. But let me tell you, those who have seen HCS in action has finally admitted that it is, ultimately, the only *truly undefeatable fighting system* ever developed. And I'm talking about *people who have a lot to lose* by admitting this... for example:

\* I know one man, who is a martial arts

instructor with 3 black belts in different martial arts, (who also trains select groups of U.S. Military special forces), was so convinced after just one month of using HCS that...

## **He Ceremoniously Burned All 3 Of His Black Belts, Saying He'd Finally Found The Undefeatable Fighting System He'd Been Searching For All His Life!**

\* A dentist, who was also a trained marksman, actually held an unloaded gun to my head and dared me to "get out of this situation with your fancy HCS"... and was astounded *one second later* to find himself disarmed and helpless! Yet I had *never practiced even once* the simple move I used – it just came "naturally" to me via my recent HCS knowledge!

\* My friend Russ, who is a skilled kick-boxer (and a bodybuilder weighing 230), taught his 130 lb. non-athletic wife just one HCS move, *one time*, and then tried to surprise her with a strangle hold – she reacted without thinking, nearly dislocating Russ's thumb and putting him on the floor so easily that it actually frightened him!

\* We had a well-known local Kung Fu instructor stop by, and he *refused* to even go up against an opponent using HCS once he saw it in action – he could instantly tell he would be helpless to defend himself, or to even get a strike in before he went down!

I could go on for pages with more examples. But here's the "clincher": My friend Bob (6'4", 240 lbs. and ripped) and I both tried to "get" at a guy using HCS who maybe weighed 150 lbs. soaking wet. It was only a demonstration, but I wasn't

holding back. Now, I weighed in at about 250 myself, and I was fresh from a recent first-place finish at a California bodybuilding show... between the two of us, this little guy should have been beaten *easily*. Yet, he dropped Bob to his knees with a little "tap" to the ribs... and I'm *still* hurting (weeks later) where I got "gently" popped. We never touched him. If it had been a real fight, the squirt said he wouldn't have been so easy on us.

## **Two Moves, The "Fight" Was Over... And We Wanted No More Of That Little Guy!**

It was the most amazing demonstration I'd ever experienced. And once *you* see HCS in action yourself, I'm sure you'll be just as amazed.

Here is how we came to discover this new scientific fighting system called HCS:

A few months ago, I was introduced to some members of the "elite of the elite" of our military's Special Operational Forces – the guys trained to go on the most dangerous missions, to overcome the most impossible odds, and to...

## **Never Lose A Fight!**

Yet they use no martial arts or other "classic" fighting methods whatsoever. In fact, for the last 5 years, a select group of the military special operational forces have been using a special fighting system developed by an ex-U.S. Army soldier with the reputation of being the one of the most dangerous hand-to-hand combat men in the world.

Select "elite" groups of the U.S. military special operational forces began using these new techniques because they needed a fighting system that would allow

them to quickly (within one or two seconds) defeat every enemy they encountered, under the worst conditions imaginable: This new system would have to work even if they were exhausted, starved (their missions often had them covering hundreds of miles on foot with no food or water for days), wounded, carrying 80 lb. packs, and operating in ridiculously cramped spaces. And here's the kicker: It had to work 100% of the time, no matter what.

### **If This New System Didn't Work, Good Men Would Die! And It Has Never Failed!**

Man, this was something I wanted to find out more about... but I couldn't. It was strictly classified by the Joyas Corporation. But I *could*, if I had the guts, meet the man who put this unique military fighting system together – that same ex-soldier who had re-invented hand-to-hand combat from the ground up.

That's how I met Jerry Peterson. Let me tell about this guy (it's a Hollywood story in itself): He was a "front line, front line" combat soldier in Viet Nam – in the thick of the most vicious jungle fighting of the war. He stayed for two tours, and the combat he experienced made movies like "Platoon" and "Rambo" look like picnics in the park. He was a star point-man in "Charlie Company" (the 173rd Airborne), which was one of the most-decorated outfits in the military

### **Jerry Was Able To Study The "Science" Of Hand-To-Hand Combat In A Personal Way Most Men Cannot Conceive Of!**

And he learned some very interesting things – first of all, he learned quickly that the hand-to-hand training he'd been given in boot camp was practically *worthless* in the field. Even the fighting styles of elite special forces (like the vicious Korean "ROK" units) were too fancy for the in-tight combat that occurred on the front lines.

So Jerry began to pick and choose among the various fighting styles he'd been exposed to: the street fighting of his youth, the most effective strikes from the hand-to-hand combat he'd mastered as a soldier, the combat moves he saw from the Vietnamese, and the tips he learned from other grunts who had survived and *succeeded* during those long, bloody days in the field.

By the time he left the army, Jerry had developed a tested, *scientific* method of "analyzing" fighting skills. He was a "fighter's fighter", and was only interested in the parts of other fighting systems that met the strict, basic principles that he

knew worked in the real world. He examined the psychology, the physics, and the human geometry of **sport fighting** (American boxing, wrestling, kick boxing, etc.), **street fighting** (both "consensual" barroom brawling and criminal attacks), and the "**fight or die**" combat of wartime. He analyzed the best Asian fighters in the world, from China, Japan, Korea and the Phillipines... and he dissected the Europeans (where the ancient fighting systems of the Celts, the Swedes and the French are still employed with great success). For 20 years he studied, becoming, quite literally...

### **One Of The Most Dangerous Men In The World At Hand-To-Hand Combat!**

Let me tell you, despite his brutal background, Jerry is one of the most concerned men I've ever met. He's seen firsthand how bad guys take advantage of decent men and women and children, and he seriously does not like it. He hates the idea of his kids, or anyone else's kids, having to walk in fear in their own community – and it wasn't difficult to talk him into creating a **new system** of fighting for civilians. One that we could bring to people like you, to people like my family and friends.

What Jerry learned in those 20 years confirmed my own nagging suspicions: He saw men and kids all over the world being confused by so-called "experts" who had no real-life experience in fighting. Jerry decided that was wrong, and he began to form his own method of fighting. But it wasn't like so many other "new" systems out there, which are a hodge-podge of "maybe's". No.

What Jerry was able to put together, based on his 20 years of strict scientific analysis, was a system that took advantage of the universal secrets of the best-of-the-best fighting systems – for the first time, the most super-effective psychological, physical, and human geometrical truths of fighting were "melted down" and...

### **Distilled Into A Basic, Simple, And Deadly System That Could Be Learned And Used With Ease By Anyone!**

In short, it's a system that would work effectively in all conditions. Here's what you get in the Hostile Control Systems package that Jerry has put together for you:

1. Two full-length video tapes, featuring Jerry himself and two actual **combat instructors** from the same organization that teaches the elite special operational forces of the U.S. military! These super hot tapes show you everything you need

to know about this new system. The tapes use live action footage, multiple camera angles, and slow motion replays – so each tape is a complete lesson.

2. A special report on Street Fighting that gives you an *inside look* at what really happens in most altercations, whether it's in a beerhall, a back alley, a busy street, or a fancy restaurant. You'll come away with a lifetime worth of "street" knowledge and savvy – that will last you forever!

3. You get a heavy manual full of illustrations and detailed explanations of everything you'll see in the videos.

4. *Plus*, you get a detailed human anatomy chart, inside that manual, illustrating all the "one-strike take-down points" you'll use as targets – along with explanations of what happens when you strike each target!

This last part is very important, and it's what sets HCS apart from any other fighting system on the planet. The reactions a human being exhibits after being hit are 100% predictable – it's called **autonomics**. That's a fancy word that simply means "the automatic reactions" of human movement. Here are a few examples of what you'll learn:

- You can easily force a man into the same violent (and involuntary) reaction *every time* simply by "targeting" his solar plexus... and he'll go down into the exact floor-space you want him to! (By the way, his solar plexus is already "pin-pointed" for you by a button on his shirt!)
- A stomp on his *shoelaces* (with no more force than crushing a bug) will produce a "two-pronged" autonomic reaction that leaves him helpless and "set up" for a simple fight-ending move your grandmother could deliver.
- There are 2 "secret" ways to instantly manipulate a man with kidney punches, both of which allow you to *end* the fight with your next decision... in your own sweet time. (It's easy to target the kidney once you understand the simple "map" of target areas we give you.)
- Forget what you see in the movies – the autonomic reaction to a groin kick is identical for every man, every time. And your *second* kick also produces a predictable response (which, if you don't step clear, might soil your shoes). Even more important, he will be left helplessly open to a devastating "tap" from you that will end his fighting days for quite awhile.

I could go on for pages, but you get the idea. This "science" of autonomic reactions comes from Jerry's 20 years of studying hand-to-hand combat *in person*.

Soldiers who study with Jerry often have to put what they've learned to the test *immediately*... and they come back with detailed results of the effects.

### **These Fighters Know – With As Much Certainty As A Pool Player Knows Where The Cue Ball Is Headed – What To Expect When They Deliver A Strike!**

The importance of this knowledge becomes brutally obvious when you see your standard downtown martial art studio in action. People are taught to deliver strikes up and down the body in rapid succession – face, neck, solar plexus, groin, knee, et cetera. Yet these multiple moves can almost never be used in a real-life situation... because the first strike will cause autonomic reactions that make the *next strike physically impossible!* Even more important...

### **Why Do You Need To Practice Multiple Strikes When Real Fighters End A Fight In 1 or 2 Seconds With One Blow!**

Black belt instructors who aren't real-life fighters simply do not have the knowledge to predict a man's physical reactions to being hit. And this creates a "mystery zone" for their students... if you can't predict how a person will react to your strikes, how can you know what to do next? I think that's ridiculous.

### **With The "Real Life" Fighting Know-how You Get From HCS, You'll Always Know What Happens Next!**

There will be no "gray areas" in your knowledge. No guessing. Not even a *shred* of self-doubt! If you ever have to use what you've learned, you will have the confidence of knowing what to expect at *each and every moment* – from the first push or insult to the moment *you* decide to end the confrontation. I can't stress how crucial that is in the real world. It's the difference between standing there blinking and being a *victim*...

### **And Walking Away As The Victor!**

Here's what *else* you're going to learn:

- How a single "secret" statement can *end* a fight in your favor before it begins!
- How to instantly "take down" aggressors even if they surprise you!
- How to identify the basic "tough guy" gestures nearly all attackers make just *before* they deliver their first blow... split seconds before they realize they're about to act themselves! (Giving you time to *end* the situation before it actually starts!) For example:

– A man will move his chin in a predictable way just before striking...

– His eyes *will change* when he's reached the boiling point...

– And you should know what's coming next when he *steps back 2 paces* or has just put his hand on your shoulder (it ain't a goodbye kiss that he's got in mind!)

- How to conquer forever the "shakes" and out-of-control anger or fear that all inexperienced fighters suffer!
- How to do ultimate damage to your targets... *without hurting your hand!*
- How to mentally *force* your attacker to open himself up to your easiest single-strike take-down moves!
- The secrets of using pain and shock to disable your opponent without causing him permanent injury.
- How to "skip" the one unforgiveable mistake almost *every* inexperienced fighter makes instinctively! (Which usually gets them hurt badly!)
- Why you *never* need to use defensive blocks... and why it's a dangerous waste of time to even learn them!
- The *single most important question* you must ask yourself – and answer – in any difficult situation!
- Your body's 12 most devastating natural weapons (including your own "personal piece of steel pipe"!)
- Your best 6 "*first strikes*" (guaranteed to drop your assailant instantly)... from a seated position, standing face-to-face, when attacked from behind, when attacked by a larger aggressor (ideal for women and kids), and more!
- How to easily turn your day-to-day attitude into an "Offensive Mindset" that won't change anything about you except:
  - Your level of fear will *vanish* forever...
  - You'll become more decisive in *everything* you do, and especially when the chips are down...
  - You'll gain **enormous self-confidence** that will shine like a searchlight in your eyes...
  - You will take total and complete *control* of every situation in your life – instead of just reacting to what happens to you (like a helpless puppet whose strings are pulled by other people!).
- How to understand the "Hierarchy of Critical Decisions" that occur in every conflict. (This is a revelation to anyone who hasn't experienced a lot of fighting – with this knowledge, you can pinpoint the *exact moments* you must choose your next action... so you are always in control, always one step ahead of the

other guy!)

And more, and more, and more. This package is truly the most amazing self-teaching method of real-life fighting you've ever seen. Just listen to what some very impressive people have to say about Jerry's fighting systems:

*"This is a gold mine, and I have concluded that Jerry has given us a means of eliminating the majority of systems and techniques that will get you killed. I have black belts in 2 different martial arts, and brown belts in another 2. What I saw on your tapes, a person mastering the techniques in these tapes would be a black belt in my book."* Rainer Eysser, Accomplished Black Belt, Bountiful Utah

*"Jerry Peterson's reputation and fighting system sets the standard for excellence in the 21st century. Based on the scientific principles for biomechanics, physics, autokinematics and Human Nature, this program delivers unparalleled performance to Professional Combat practitioners and civilians alike. Using unique training methods, this program teaches combat skills that students can quickly learn and utilize."* Dr. Donald J. Walker, San Diego, CA.

*"I earned a first-degree black belt while training in Japan in what I thought was the most effective martial art in the world... but after seeing how fast the methods used in Hostile Control Systems can eat up even an experienced fighter like myself, I'm convinced this new system is the way to go."* Kelly Dyrge, Instructor/Owner Full Force Kickboxing

*"Your HCS videos are excellent. The slow-motion and detailed breakdowns are very helpful in learning the moves."* Rick Shedden, Gillett, PA

*"I am very pleased. The Hostile Control Systems package was great and I mastered it in about 6 days of practice with my partner."* Kel Morris

*"...it's short, to the point and exactly what I've been looking for. (Jerry), gives needed details and stays on your level."* Andrew Adams, Hesperia CA

*"Since training with Hostile Control Systems just a few weeks, I must agree the program is 'ultimate self defense'. This technology is a must for every person interested in survival, regardless of past martial arts experience."* Steven Blackmon, Concord CA

Let me stress something here – **you need this information!** It is not a luxury, not in today's world. I just saw some video tape on t.v. of convicts in prison... you know what they were doing during their "free

time" in the prison yard? Teaching each other how to sneak up and rob people, how to choke and drag off victims without sound, how to hurt and cripple and *destroy people's lives* just to satisfy their sick needs. In short, they were "going to school" to learn how to take advantage of you once they get out!

Do you want to be a victim? Do you want your loved ones to be victims? Do you want to walk around with a layer of sweaty fear on your skin all the time, knowing you're vulnerable at every street corner to being assaulted, robbed, or worse? I sure don't, and I don't believe *you* do, either. It's time to learn how to take care of yourself.

This information does not insult your intelligence in any way – there are no mysterious Oriental chants or religious nonsense to learn. You do your learning at your own pace, at home. You can learn fast, too...

**In A Remarkably Short Period Time  
You'll Surpass The Fighting Skill  
Of Guys With 10 Years  
Experience In Martial Arts!**

That's because this stuff is based on **what works in real-life fights** that take place in one or two seconds. You need no previous experience in any kind of fighting whatsoever – we'll show you *everything* you'll ever need to know. You don't need to be strong, quick, agile, or even in shape. And every move is base

on the way you move *naturally* – there's no gymnastics involved, no spinning kicks, no jumping, no fancy moves of any kind.

Though let us be clear on this: **You must take total responsibility for your actions** – this is a "use at your own risk" type of product, and you can understand why I have to say that. What we're teaching here is the most effective fighting method on the planet... used correctly, and you will be able to defeat anyone – unless they happen to be a member of the elite Special Operational Forces of the US Military. But we can't make you invulnerable to the world – this is your best-possible defense against aggression, but it's not fool-proof. Just so long as we understand what's going on here, all right?

I'm not asking you to take any financial risk. I'm going to make it as simple as possible for you to try this amazing Hostile Control Systems out for yourself... without risking a dime. Here is my

**100% No-Nonsense Guarantee:**

If you aren't convinced that this system is everything I've said it is... a no-guess work, tested in real battle conditions, easy-to-learn *fast* course in turning yourself into the most formidable fighter you could ever dream of being... after *trying it out* for 3 entire months, then I insist you return the package to me, and I will immediately send you a 100% refund of your purchase price. No questions asked, no hard time from

me... and we'll still be friends. I trust your opinion, and I believe you won't take advantage of me on this "almost too-generous" guarantee.

That's a darn good, no-risk-on-your-part guarantee. And it means, simply, that there isn't any reason in the world for you not to try this incredible fighting system out for yourself. Within those 3 months, you're going to acquire confidence like you never imagined possible before... and you're going to learn fighting skills and know-how that will place you in the *upper 2% of the world*... including all those guys who have been slaving away at their martial art for 5 and 10 years.

**So How Much Does This  
HCS Package Cost?**

Not very bloody much. At first we thought of making it a very "elite" course, available only to a few people who could afford a very steep price tag. But that didn't sit right with me – I wanted to get this information out to *everyone* who deserves to get it.

So, we finally came up with a price that is fair to everyone. The cost to you for this whole package – the 2 video tapes, the manual, the special report – is just \$69 + \$5 for shipping and handling, (Total \$74). That's a one-time-only, introductory price for *Soldier of Fortune* readers only. **IT'S EASY TO ORDER:** Call our toll-FREE phone number – **1-800-582-2083**, ask for dept. 55-H – and use your credit card. Or, if you prefer, you can fill out the Priority Order Form, and mail it with your check or money order. We'll ship your package out first-class just as soon as we receive your order.

That's all there is to it. You have my *personal guarantee* your package will live up to your expectations... or you get your money back. This is the real thing, too – it's changed my life, and the lives of my loved ones. It's a confidence-booster, and the best way I've ever experienced to put you in control of your life 100%. So call right now... you never know when you're going to need the know-how and skills you're about to learn!

Sincerely,

*Leo Costa Jr.*

Leo Costa, Jr.

P.S. I almost forgot something important. We've only put together a small number of these HCS packages, so you really need to call *today* to make sure you get one reserved for you. It's a great deal, but there may not be enough packages to go around without delays. Just give us a call at **1-800-582-2083**, and make sure you get *your* package now. Thanks.

**Priority Order Form For *Soldier of Fortune* Readers Only!**

*For The Fastest Delivery, Use Your Credit Card And Call Toll-FREE*

**1-800-582-2083 (Ask For Dept. 55-H)**

**YES!** I'm finally ready to take responsibility for protecting myself and my loved ones, and I can see that this amazing Hostile Control Systems video package can quickly give me the devastating knowledge and skills I need! I understand that I can try out this package for a full 3 months, at my own pace, and if I'm not satisfied – for any reason, or for no reason – then I can return it for a complete, prompt and 100% refund of my purchase price. It's a great deal, with no financial risk on my part whatsoever; thanks, Leo!

⇒ \_\_\_\_\_ By initialing this line, I am stating that I am over 18 years of age and that I have never been convicted of a felony. I also state that I will use the information contained in Hostile Control Systems in a defensive situation only. I accept sole responsibility for my actions as an adult.

Name: \_\_\_\_\_

Address: \_\_\_\_\_

City: \_\_\_\_\_ State: \_\_\_\_\_ Zip: \_\_\_\_\_

My check or money order in the amount of \$74.00 is enclosed.

Bill my:  Visa  MC  Amex  Disc Card #: \_\_\_\_\_

Exp. Date: \_\_\_\_\_ Signature: \_\_\_\_\_

Foreign orders must pay additional shipping & handling. Call 1-209-732-5378 for details.  
(CA orders add \$5 sales tax.) Rush shipment available for extra fee.

**Optimum Training Systems  
2945 S. Mooney Blvd., Dept. 55-H  
Visalia, CA 93277**

## DEGAN ONE OF THE GOOD GUYS

In your December edition you referred to the "Feds" as not being the good guys. Well I can tell you one "Fed" that was one of the best: Deputy Marshall William Degan — the very same man Randy Weaver allegedly murdered.

I had the privilege of serving with Lieutenant Colonel William Degan in the Marine Corps Reserve for well over a decade. Never have I seen a man who exemplified the finest traditions and ideals of the Corps so well. He was a superb leader because he always remembered that the most important function of any Marine officer or NCO was to take care of his men.

While no one likes to see a brother law-enforcement officer killed in the line of duty, Degan's death was particularly difficult for his friends and members of the unit he commanded, and his murder can in no way be justified.

The very criminal justice system and its shortcomings that you complain about in your publication saw fit to release a person who was directly responsible for a chain of events that lead to a number of deaths. It doesn't take a genius to realize that this is not morally acceptable.

When you look at the state of contemporary America you'll see that law enforcement officers are the "good guys," and Bill Degan was one of the best.

Staff Sgt. John Butler, USMC  
NAS S. Weymouth, Massachusetts

## LOSING A NO-WIN WAR

Prior to reading Hack's article "Why We Lost In 'Nam" in the December issue, I didn't know that Colonel Sum-

mers was strictly a staff type. But some years ago, after reading the book *On Strategy*, that was the impression I got. The strategic concepts expressed in this book might have worked if South Vietnam had been say, Vermont, being invaded by Canada.

The military effort in Vietnam was doomed to failure from the beginning because of wishful thinking by U.S. policy makers. There never-

deal for many high-ranking military officers, who, with their air-conditioned quarters, Oriental girlfriends etc., never had it so good. Think it through. Is it any wonder they liked the war?

D.J. Fitzgerald  
Lake George, New York

## GOTTA GET DOWN AND DIRTY

As a recently discharged soldier of seven years' service with the 101st (one of Col. Hackworth's old outfits), I read the December *SOF* with great interest. And I can attest to his criticism of the modern Army's failure to incorporate the strategic and tactical lessons learned in Vietnam.

I found the modern U.S. Army wanted no part of down and dirty, blood and guts combat training. I was told

by COs that there is no need for that kind of training on the modern battlefield. One platoon leader even accused me of being too mean. And one of the soldiers in my unit was ordered to leave behind his massive bowie knife during the Gulf War because "it doesn't look good."

My philosophy when it comes to fighting a war is that you have to be better armed, better trained and willing to take the initiative and get down and dirty before the enemy has a chance to do you in. Maybe it's because I'm Oriental that I'm more barbaric in terms of fighting and killing, or maybe it's because I've seen too many deaths as a result of war, but whatever the case, I give up the notion of humanity when it comes time for battle.

As for the Vietnam War, the blame lies with the Vietnamese people. The South Vietnamese were



ally was a nation called South Vietnam. The control of terrorism, which in any organized society would be considered crime, is at the most basic level a quasi-police function and can never be accomplished by soldiers who look different and speak a different language, except perhaps temporarily when the most Draconian methods are applied. Imagine the result if a big city police force in this country were staffed by Chinese-speaking Chinese.

The only hope for achieving "victory" in Vietnam would have been through prolonging the war indefinitely and employing relatively small units of professional soldiers (thus eliminating the ire of draftable college kids and their parents). Vietnam never posed any threat to the United States, nor offered any equitable economic gain. American involvement was, however, a nice



too dumb to believe the Northern refugees who escaped Uncle Ho's red horde in 1954. My family was from the North and we told the South Vietnamese of the monster called communism, but they didn't believe us. They reasoned that, after all, we were brothers of the same blood. They found out how wrong they were in 1975. Unlike Col. Hackworth, I don't find my adversaries worthy of respect. I have nothing but contempt and hatred for the traitors of our ancestors. For that, their deaths cannot be torturously painful enough. Sat Cong!

Keep up the good work. My thanks go to America and its Vietnam vets. We owe you big time.

Air assault!

H.T. Dang

Albuquerque, New Mexico

### HE MIGHT BE THEM

This is in reference to the letter in your December issue titled "We Ain't Them," obviously written by a cop (though his name was withheld).

I have no problem with the concept of his letter but I question just how far he is prepared to go to

back up what he's saying. Is he willing to, when his supervisor tells him to go collect guns in his town, lay down his badge and refuse? Is he willing to give up his paycheck and work as a bag boy in a grocery store or janitor in a school? Somehow, I just don't think so.

When things get worse (and they will), which side will he be on? How far is he prepared to go?

D. & J. Scriver

Sheridan, Wyoming

### MONUMENTS DON'T TELL THE STORY

In your December issue you list the names of American servicemen who died while Clinton was in Moscow. One of the names listed is that of Gerald Jackson.

Gerry and I went to jump school together and were then both assigned as second lieutenants to B/1/325 Infantry, 82nd Airborne. A young black man from Florida, Gerry was one of the finest officers I had the opportunity to serve with. He was an outstanding human being who was highly respected by all the officers and NCOs in the battalion.

He also had the most beautiful singing voice I ever heard. When he would count cadence or sing jody, it would send a chill down our spines. A voice like his belonged in an opera house, not on a P.T. field.

I learned of his death the day before I left the battalion for Vietnam. Twenty-three years later, I still think about Gerry occasionally and grieve his death. Although we only served together for a few months, I recognized him as one of those rare individuals who it was a real honor to have known.

What's the purpose of this letter? With time, monuments become just another piece of architecture. I just wanted some of your younger readers to know that the names on the wall were real people — friends, husbands, fathers, comrades-in-arms. Ironically, a lot of fine men have died in our country's history to preserve the system that can elect a draft-dodger as president.

Thanks for the fine magazine and keep up the good work.

Jim Kwicien

Manitou Springs, Colorado

# ONCE IN A LIFETIME OPPORTUNITY!

*The New Improved*

## The Poor Man's **JAMES BOND**

Now you can own THE POOR MAN'S JAMES BOND! By special arrangement with the author, we have printed only 4000 copies! Just reviewed by the FOX network! The most infamous book ever written! NOW available for about 50% of what competitors offer it for! **Only \$12.00! Regular \$22.00!** For the public only, 477 pages of the most valuable information a patriot/anarchist could ever desire!

**Not ~~\$22.00~~ ONLY \$12.00**

24 Hour Order Line 318-688-1365 FAX 318-688-1367

**N.I.C. INC.**

500 Flournoy Lucas, PO Box 5950-JF  
Shreveport, LA 71135-5950

Order Name \_\_\_\_\_

#B450 Address \_\_\_\_\_

\$12.00 plus City/State/Zip \_\_\_\_\_

\$3.00 per Card# \_\_\_\_\_ Exp \_\_\_\_\_

book P&H VISA  MC  M/O  CHECK

**SAME DAY SHIPMENT!**



# THE GENUINE LEATHER U.S. ARMY FIELD JACKET



Millions of fighting men swear by it. Now, you can own it in genuine leather!

■ Ask any man who ever owned one...he'll tell you it's the best jacket he ever had. For millions of G.I.'s, the official issue U.S. Army Field Jacket was the most prized piece of gear from Army days. Earning its stripes from World War II to Desert Storm, it always came home with the troops. Now, *The Genuine Leather U.S. Army Field Jacket* combines the rugged good looks and comfort of the jacket that veterans treasure with the richness of supple genuine leather! Available exclusively from Willabee & Ward.

**Authentic Details.  
Practical Hip-Length Cut.**

All the great features that made the original so popular are here. For starters, there's the famous fit and cut. It's comfortable and it covers you to the hip. The regulation shoulder epaulets, roomy snap-close pockets, zipper and snap-front closures, adjustable cuffs, and drawstrings at the waist and hip. What's more, we've updated the classic design by adding convenient side-entry pockets, two zippered inside breast pockets, and a comfortable satin-blend lining. The result is a great-looking jacket that's perfect with jeans, yet the luxurious genuine leather makes it dressy enough for a night on the town.

Also available in Black Leather.



- Regulation epaulets
- Roomy snap-close pockets
- Zipper and snap closures
- Waist and hip drawstrings
- Adjustable cuffs

**Just \$199. Convenient Monthly Installments.**

*The Genuine Leather U.S. Army Field Jacket* is available in brown and black and is priced at just \$199 (plus \$9.50 shipping/handling), payable in six monthly credit card installments of only \$34.75. Comes with a 30-day money-back guarantee. Available in sizes S, M, L and XL. Call about larger sizes (XXL and XXXL) for \$50 more. Have questions about sizing? Call us — we'll fit you over the phone. Phone orders normally shipped next business day.



**CALL TOLL-FREE: 1-800-367-4534**

EXT. 685-241

© 1993 MBI

Willabee & Ward  
47 Richards Avenue  
Norwalk, CT 06857



Satisfaction  
Guaranteed

**CALL TOLL-FREE: 1-800-367-4534** Ext. 685-241

Please send me \_\_\_ *Genuine Leather U.S. Army Field Jacket(s)*.

Sizes(s) (Circle): Small Medium Large Extra Large  
(38-40) (42-44) (46-48) (50-52)

Color(s) (Circle): Brown Black

For each jacket, charge 6 installments of \$34.75\* to my credit card  VISA  MasterCard  Discover  Am. Ex.

Credit Card # \_\_\_\_\_

Exp. Date \_\_\_\_\_

Name \_\_\_\_\_

(PLEASE PRINT CLEARLY)

Address \_\_\_\_\_

City/State/Zip \_\_\_\_\_

Signature \_\_\_\_\_

(All orders subject to acceptance.)

I prefer not to use a credit card and will pay by check.  
Enclosed is my check for \$199 plus \$9.50 shipping/handling, a total of \$208.50\* for each jacket.

\*Any applicable sales tax will be billed with shipment.  
Higher shipping/handling outside U.S.

**THE LONG GOODBYE**

As a commissioned officer who served in the Rhodesian and South African armies, I would like to thank you for your unswerving support for those countries since you commenced publication of *SOF*.

It was certainly an inspiration to myself, as well as others I served with, to see you and your staffers place yourselves in harm's way in Africa's war zones in an effort to relay the truth about our activities and achievements. In this you stood alone, a lonely voice amongst the trash bins of left-wing liberal publications.

Now that South Africa, the only remaining outpost of civilization, is about to fall into the hands of the mob, the last light of Western democracy will fade from the dark continent. However, be that as it may, *SOF* was there and your efforts did not go unappreciated. For your cour-

age and dedication for our cause, and on behalf of those who fought and died and those who just fought, I thank you and salute you.

David Scott-Donelan  
South Africa

stream media's game of crying discrimination or unfairness.

I'm sure they would have loved to have him rant and rave and help further their cause of dividing America, especially after the great success they enjoyed with the Rodney King spectacle. To me, Denny displayed "brotherhood" which is, after all, supposed to "crown our good from sea to shining sea ..."

Name withheld by request

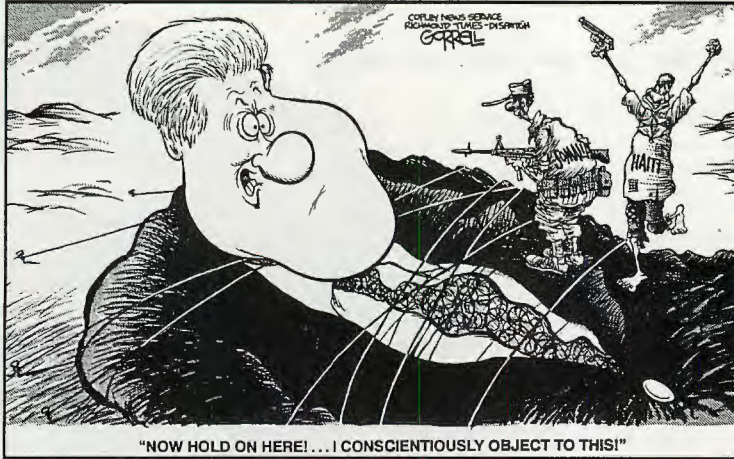

**DENNY SHOWED CLASS**

Three cheers for Reginald Denny! I thought he showed true American spirit after the verdicts were read for his accused attackers. He stated that he was happy with the verdicts and that it had gone on long enough. He didn't play the main-

**LETTERS TO FLAK**

*SOF* invites readers comments. Due to limited space we reserve the right to edit for content and brevity. Submitting letters to *FLAK* constitutes permission to publish and authors receive no payment. Names and addresses will be withheld on request. Send your letter to *SOF*, c/o *FLAK*, PO Box 693, Boulder, CO 80306. ✕

**The Leader In Technology for Seeing, Sighting, Photographing and Videotaping In The Dark**

**NIGHT VISION WEAPON SIGHTS & VIEWERS**



I GEN.  
**AN/PVS-2B**  
Weapon Sight  
**\$1695<sup>00</sup>**  
Plus \$100<sup>00</sup> for weapon mounting



I GEN.  
**SC/PVS-200**  
Viewer  
**\$1695<sup>00</sup>**

II & III GEN.\*  
**AN/PVS-4**  
Weapon Sight  
**\$2850<sup>00</sup>**  
New with Excellent Cond. Intensifier \*III Gen. POR



III GEN.  
**OSPREY**  
Mini-Weapon Sight  
**\$5800<sup>00</sup>**  
NEW UNIT

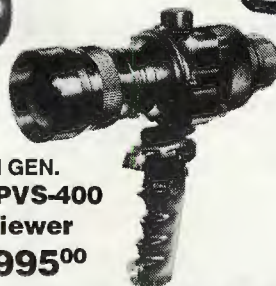

II GEN.  
**SC/PVS-400**  
Viewer  
**\$2995<sup>00</sup>**

**NIGHT VISION GOGGLES**

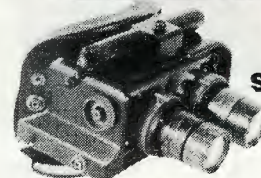

II GEN.  
**NVG-500**  
Starlight Goggles  
**\$5850<sup>00</sup>**  
NEW

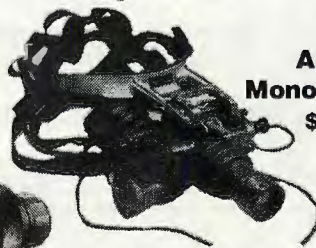

III GEN.  
**AN/PVS-7B**  
Mono-Tube Goggle  
**\$4850<sup>00</sup>**  
(Standard Unit)



II & III GEN.\*  
**NIGHT EXPLORER**  
Pocketscope  
**\$2195<sup>00</sup>**  
New with Excellent Cond. Intensifier \*III Gen. POR

**STANO Components**

**Catalog \$4<sup>00</sup>**

P.O. Box 2048 • Carson City, Nevada 89702 • (702) 246-5281 / (702) 246-5283 / Fax (702) 246-5211

# ANOTHER PEACETIME CASUALTY

You don't have to be in the service to appreciate a good boot. But it helps.

*We don't cement our EVA midsoles and Vibram® outsoles to the uppers, we stitch them. That way they can be resoled some day.*

Thirty-mile forced marches, maneuvers in Alaska—it's familiar territory to a company that began outfitting loggers and trappers 54 years ago.

So we weren't surprised to hear a while back that some lieutenants from Fort Lewis were buying our boots and dyeing them.

"Why don't you make these in black?" they asked.

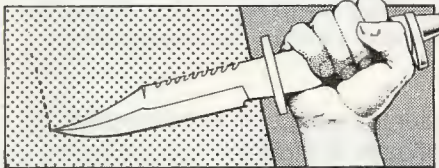

*Our 1000 denier Cordura™ nylon insets have ten times the tensile strength of leather. And less than half the weight.*

That sounded like an order to us, so we had our full-grain



*One firefighter said our Thinsulate™ insulation was so good he couldn't tell his boots were on fire.*

leather tanned black inside and out (that way it doesn't show white at the

seams), cut it two inches taller at the top (so you can tuck your pants in), and added D-rings (for dress wear).

And now we're even taking orders from raw recruits. All over the country.

But you're not the only people who work with your feet.

Think of the police.

Firefighters.

Letter carriers.

We did, and

we now offer

*We were the ones who invented the waterproof Gore-Tex™ liner seven years ago.*

the full range of service footwear, including the only walking shoes



with components proportioned to size. And with heel wedges designed to disperse shock.

No matter what you do, call Danner for the boots and shoes

to do it in. Because chances are it's not your feet that are killing you. Chances are it's the other way around.

**Danner**

Call us for a free brochure or the name of your nearest Danner dealer.  
1-800-345-0430.



Text & Photos by Peter G. Kokalis

While the 12 gauge scattergun will still be found in most patrol cars throughout the country, a number of law enforcement agencies are taking a close look at the so-called "police carbine" concept to either replace or supplement their shotguns.

The reasons are not difficult to discern. The 12 gauge shotgun's recoil is not insignificant. With more and more females to contend with, this looms as an important consideration for most departments. Furthermore, in an urban law enforcement environment, all of a shotgun's multiple projectiles must be accounted for. Any that miss the target may strike an innocent bystander with subsequently unpleasant legal consequences.

Carbines can be chambered for either rifle or handgun cartridges. The FBI, apparently trusting its agents with firearms no more than it does the rest of us, has adopted a semiautomatic-only version of the H&K MP5 submachine gun which, I guess, makes it a carbine. In the past, both the Winchester Model 94, caliber .30-30, lever-action carbine and the semiautomatic U.S. .30 M1 Carbine have been popular with police units. Early on, the Winchester Model 1907 autoloading rifle and its rather anemic .351 SL semi-rimmed cartridge were often seen in the hands of prison guards and in the trunks of squad cars. Jeff Cooper and some of his more mindless myrmidons have even suggested rather emphatically that the Winchester M94 is superior to the Kalashnikov as an infantry weapon.

That peculiar aberration aside, a strong case can be made for a lightweight, compact shoulder-mounted carbine as an auxiliary to a police officer's sidearm. A weapon of this type is also usually a better choice for the homeowner than a handgun.

Shoulder-mounted firearms provide greater hit probability at



Lightweight and compact, a strong case can be made for the Marlin Camp Carbine as an auxiliary to a police officer's sidearm. It is also usually a better choice for the homeowner than a handgun.

longer ranges than a handgun for most shooters. When facing an armed opponent, hitting the target in a vital area before he shoots you is more important than any other factor in the survival equation.

If the carbine is chambered for the same cartridge as the handgun we are carrying, all the better. In the United States, this is a historically popular concept and many Winchester lever-actions were chambered for the .44-40 and .38-40 cartridges that rotated in the Colt Single Action cylinders packed by cowboys and roughnecks of all kinds in the early West.

Marlin's popular Camp Carbines are chambered for either the 9x19mm Parabellum or the .45 ACP rounds that still prevail with law enforcement agencies in the United States (although the .40 S&W cartridge is moving up fast).

While they possess none of the terrifying attributes of "assault weapons," such as flash hiders, bayonet lugs, pistol grips or folding stocks, they are, nevertheless, semiautos. Thus, as all semiautomatic firearms are now on Sarah Brady and Slick Willie's hit lists, *caveat emptor*. Newspaper accounts of shootings used to

identify weapons as either pistols, rifles or shotguns. Now, invariably, they are referred to by the apparently more nightmarish media-term "semiautomatics."

Be that as it may, the Marlin Camp Carbine is a semiautomatic firearm that operates by means of pure, unlocked blowback (a consequence of the relatively low pressure pistol calibers for which it is chambered and the massive bolt permitted by a larger, shoulder-mounted firearm). It fires from the closed-bolt position.

Marlin uses what they call Micro-Groove rifling in the 16.5-inch barrel. Overall length is 35.5 inches. The weight, empty, is approximately 6.75 pounds.

There is an M1 Garand-type safety lever in the trigger guard. Push it forward to place the trigger mechanism in the "fire" position. There is also a magazine disconnect safety; the carbine will not fire without the magazine in place. Trigger pull weight on our test specimen was a rather heavy 7.5 pounds.

A spring-loaded bolt hold-open is activated by the magazine follower after the last round has been fired. It can also be manually activated by a bar with a button on the left side of the

magazine-well, just above the magazine catch/release button. This latter feature is of dubious value, in my opinion. The magazine-well and trigger housing are a single integral injection-molded plastic component. The extractor also serves as a loaded-chamber indicator. The fixed ejector is attached to the left side of the interior of the magazine-well/trigger housing.

The open, U-notch rear sight can be adjusted for elevation by lifting it up at the rear and sliding a stepped and ramped steel bar forward or rearward and by drifting in its dovetail on the barrel for crude windage adjustments. The front sight, a bright orange plastic blade-type is protected by a sheet-metal hood with a cutaway top. The top of the receiver is drilled and tapped to accept a scope base and the rear sight can fold down



K.C. Enterprises modified this Marlin Camp .45 to accept Para-Ordnance P14.45 13-round magazines.

for this purpose.

The stock, which appears to be walnut-stained birch, has a rubber recoil pad and sling swivel studs at the conventional locations.

Wherever possible, sheet-metal stampings and injection-molded plastics have been employed to make the Marlin Camp Carbine as cost-effective as possible. The suggested retail price is about \$374.

The .45 ACP version uses Colt-type, single-column, 7- or 8-shot M1911A1 magazines. The 9mm model is constructed to accept the S&W Model 6900 series staggered-column, 12-round pistol magazines.

All of this is just fine as far as it goes, but not everyone carries a Colt Government Model or S&W Model 6906 pistol. K.C. Enterprises (Dept. SOF, 7240 South Ridge,

Madison, OH 44057; phone: 800-726-5231) has developed a conversion system to modify the Marlin Camp Carbine magazine-well to accept a large variety of pistol magazines.

Marlin Camp Carbines chambered for the 9mm Parabellum cartridge can be altered to accept magazines from any of the following pistols: Glock 17, Ruger P89, Beretta 92, Browning High Power, Czech CZ75, Korean Daewoo DP-51, Colt American 2000, Taurus Model 92, Springfield Armory P9, EXCAM-FIE75, TA-90, E.A.A. Witness, AT-88, AT-84, Jerico, SIGARMS P226, Colt M1911A1.

Marlin Camp Carbines chambered for the .45 ACP cartridge can be altered to accept magazines from the SIGARMS P220, S&W 4500 series, Ruger P90, Star Firestar, E.A.A. Witness and Para-Ordnance P14.45.

After the magazine-well has been machined on CNC (Computer Numerical Control) equipment, it's fitted with a new, steel magazine catch/release. Altered magazine-well/trigger housings with a magazine catch/release cost \$59.95. Installation costs \$15. A complete magazine-well/trigger housing assembly, which includes all parts such as the complete trigger mechanism, safety and ejector, sells for \$124.95 and can be simply dropped into your Camp Carbine. Due to the complexity of the modifications, conversions for the Glock 17, E.A.A. .45 ACP Witness and Para-Ordnance P14.45 are available only as complete magazine-well/trigger housing assemblies — the price is \$149.95. This conversion voids the Marlin factory warranty.

Complete Marlin Camp Carbines altered to accept the magazines of any of the pistols mentioned are available for \$410 (\$420 for conversion to accept Ruger P89 magazines and \$435 for Glock 17, E.A.A. Witness .45 and Para-Ordnance P14.45 conversions). K.C. Enterprises can also supply standard or look-through scope mounts and rings (\$9.95), oversize magazine catch/

Continued on page 67

# STEROIDS

ALTERNATIVES

ALL PRODUCTS 100% NATURAL  
NO HARMFUL SIDE EFFECTS

- 1 ■ **DIBENCOZIDE 10 mg** is the most powerful steroid replacement on the market & 100% legal. *World records have been set while using this product!*  
**2 month cycle \$22.50**
- 2 ■ **BORON 10 mg** naturally enhances testosterone levels so you can build muscle *without the harmful side effects of illegal steroids.*  
**3 month cycle \$15.95**
- 3 ■ **GROWTH HORMONE RELEASER G.H.R.X.** Releases growth hormone in an abundance like no other. *Works great with Boron.*  
**60 tabs \$21.00**
- 4 ■ **LEGAL STEROL COMPLEX** enhances growth. Allows body to stay pumped longer. Releases growth hormone and *strips away fat!*  
**60 tabs \$19.95**

LIFETIME 100% MONEY BACK GUARANTEE

Buy Products 1, 2 & 3 and get #4 FREE. This will enable you to have the most powerful natural anabolic stack on the market.

ORDER NOW! C.O.D.'S WELCOME

1-800-398-6946 Ask for ext. 120

Send Check or M.O. (Add \$4.00 for shipping)



**S&K LABS**

2637 E. ATLANTIC BLVD., SUITE 101.  
POMPANO BEACH, FL 33062

**COD**

## 1994 CALENDAR Women Weaponry



ALL COLOR EACH MONTH  
AVAILABLE FOR FRAMING.

**\$14.95** Plus \$3.00  
S&H each

**Great Gift Idea! FREE UPS**  
2nd Day Air on orders of 3 or more.

◆ money order only for 2nd Day Air ◆

Send your name, address and  
check or money order payable to:

High Caliber • 925 W. Baseline Rd.  
Suite 105-K26 • Tempe, AZ 85283

# WORLD SITREP

1

## UNITED STATES

Pentagon agrees to investigate whether U.S. soldiers were exposed to chemical weapons during Gulf War ...

2

## CANADA

New Prime Minister Chretien seeking more independence from U.S., cancels orders for 43 EH 101 helicopters, which he said were designed to hunt Soviet submarines and now serve no purpose ...

3

## NORTHERN IRELAND

IRA announces it will attack companies doing business with British military ... Sectarian killings sharply escalate; Britain rejects IRA peace offers, considers resuming "internments," the locking up of suspected terrorists under martial law without trials, a policy unused since 1978 ...

6

## TADZHIKISTAN

More than 70 Islamic militants killed fighting Russian border guards near Gorno-Badakhshan ... Iran denies it supports Tadjik rebels ...

7

## GEORGIA

20,000 Azeris flee to Iran following 48 hours of fighting as Georgian troops recapture Senaki in new offensive ... Rebels retake Senaki after four days, only to lose it again two days later ... Khobi changes hands five times over eight days, with Georgians victorious ... last rebel troops flee into Abkhazia ...

8

## BOSNIA

Many troops in Sarajevo say they fight only for their lucrative black-market operations, not for city ... U.S. apparently gives up seeking NATO approvals for air strikes on Serbs, also backs away from sending U.S. peacekeepers ... U.N. troops accused of patronizing Serb brothel housing captured Croat, Muslim women ... Serbs arrest 18 *Chetnik* militia commanders for war crimes ...

3

11

## ISRAEL

Peace agreement with PLO shaky; new Palestinian "police force" subject of major miscommunication — Israelis envision a few hundred police carrying pistols while Palestinians want 30,000 troops with SMGs, assault rifles, choppers, gunboats and APCs able to defend against "foreign invasion" ... Leaked U.S. Senate report confirms years of rumors that Israel sold China billions' worth of high-tech weaponry (some with U.S. technology) over the past decade ...

1

12

## LIBYA

Intel surfaces on failed mid-October military coup attempt against Khadaffi launched by commander of Libyan forces in Chad. Renegade armor column was battered by air strikes and smashed by loyal troops; some 250 rebel troops killed, several hundred captured. Other small mutinies erupt over lack of pay. Ringleaders arrested and executed ...

13

## CHAD

Rebel leader Abbas Kotti killed in brief coup attempt backed by some army officers; Kotti returned from exile to sign peace agreement with government only a week earlier ...

15

## SOMALIA

Clan fighting escalates; U.S. and U.N. troops ordered not to interfere ... President Mubarak of Egypt agrees to take over U.S. mission after American pullout ... Somalis seen carrying guns and driving "technical" vehicles through Mogadishu once again ...

16

## ANGOLA

U.N. claims Unita willing to give up vast territorial gains captured over past year, yet rebel attacks continue despite approach of peace talks ... MPLA troops drive toward Huambo, also destroy Unita base near Zaire border, killing 47 guerrillas ... Unita prepares assault on Menongue, shells Ukuma ...

17

## INDIA

More than 50 Muslim demonstrators killed by government troops in Kashmir; Pakistan refuses to negotiate with India unless troop levels in Kashmir are reduced ... India accuses U.S. of favoring Pakistan in Kashmir troubles, yet Pakistan offers U.S. no concessions on nuclear proliferation dispute ...

18

## SRI LANKA

Military helicopters, gunboats attack convoy of about 100 Tamil rebel boats ferrying civilians across Jaffna Lagoon ... Some 250 soldiers killed in massive Tamil attack beginning three-day siege of Pooneryn army camp on Jaffna Peninsula; rebel fire prevents resupply by air — one Sri Lankan regiment holds out — government troops land by boat to break siege, more than 1,000 more arrive overland; each side loses around 400 men during battle ...

4

### GERMANY

Iranian agents have trained in Germany as recently as '92 — country provided computers and photo equipment to Iran to further cooperation ...

5

### RUSSIA

New military doctrine unveiled, cites foremost threats from small regional wars rather than global conflict; troops to be kept on alert only to defend borders ... "first use" of nukes not ruled out ... Bear, Backfire, Blackjack and Fencer bombers will form "strike packages" for conventional missions ... Two cosmonauts on Mir space station told they must remain in orbit an extra two months due to shortage of booster rockets for a relief flight ... Senior officer of elite Alpha commando group says his men may be forced to retire since they ignored "shoot to kill" and "shoot everyone" orders when storming Russian parliament during fall coup attempt ...

5

### TURKEY

Death toll from nine-year Kurdish rebellion reaches 10,000, including 4,517 PKK rebels, 3,144 civilians and 2,270 security troops ... Turkey vows to deploy 10,000 volunteer commandos to crush rebels ... Kurds coordinate international attacks on many Turkish commercial and government targets in 28 German cities, also in London, Copenhagen and Vienna ...

10

### IRAQ

Opposition group claims Baghdad recently used poison gas on southern Shi'ite rebels, killing hundreds ... Two Swedes released from Iraqi prisons say Kuwaitis are still being held prisoner from Gulf War ...

4

8

7

9

10

11

12

13

14

15

6

17

18

19

20

21

14

### BURUNDI

Insurgent army units strike presidential palace, media stations in dawn coup; soldiers execute President Ndadaye and five senior officials ... tribal war erupts between Hutus and minority Tutsis — thousands killed, 760,000 flee ... army brands coup a mutiny; Prime Minister Kinigi assumes power, vows to punish rebel soldiers ... France sends advisers to help reform military ...

16

19

### CAMBODIA

Mine-clearing authority says \$12 million needed annually for a decade or more to remove some 10 million land mines still planted over country ... Cambodian air force repaints helicopters from blue to cammo, then deploys them against Khmer Rouge holdouts ...

20

### NORTH KOREA

Development of 1,000km-range Rodong missile nearly complete ... military shaves heads of all soldiers to combat lice, yet possibly signaling war preparedness ... country out of food, money, low on oil — without Russian or Chinese cash, economy destitute ... U.S. reportedly rules out air strikes on nuclear facilities due to potential radiation release ...

21

### SOUTH KOREA

Generals meet with U.S. commanders, agree to delay decision on whether to hold '94 joint Team Spirit war games, which agitate North Koreans ... Clinton warns any attack on South Korea is assault on U.S., while top U.S. Gen. Shalikashvili says U.S. has no plans to withdraw troops from country ...

World SitRep is excerpted from the biweekly newsletter *For Your Eyes Only: An Open Intelligence Summary of Current Military Affairs*. Published by Tiger Publications, P.O. Box 8759, Amarillo, Texas, 79114-8759; subscriptions are \$65 per year (26 issues). Sample issue available for \$3. Those interested in reliable, up-to-date world intel are encouraged to subscribe.



# COMBAT WEAPONCRAFT

by Louls Awerbuck

With each month's crop of gun publications comes the "news" that somebody has invented a "revolutionary" new pistol-bullet/cartridge combination that will stop a charging elephant. Six months later it is decried as outdated, and superseded by the next ballistic magic wand.

Although we who write about such developments have expended reams of paper and miles of typewriter ribbon examining various developments in this arena, the purpose of this particular article is not to prove which one caliber or bullet, if any, is the best performer, but rather whether handgun caliber, within reason, makes the pivotal difference when the chips are down.

First, there are few people of Fackler's Ragsdale's or DiMaio's ilk who have the knowledge of terminal ballistics and human physiology to even begin a rational discussion on the subject. Secondly, there has been so much bastardization of available data since the turn of the century that much of the so-called factual statistics are, in fact, only folklore.

This having been said, it comes down to an honest appraisal of what works and what doesn't. Documentation of actual occurrences is the only true guideline, and the front runner of such is the Thompson/LeGarde tests conducted in the early 1900s. The only problem with these tests is that they were conducted on human *cadavers* and cattle — not the same as shooting at a cocaine addict hell-bent on destruction.

The most common discussion on handgun calibers through the 20th century has undoubtedly been the .36 versus .45 argument — most frequently the 9mm Parabellum versus .45-auto debate. The .45



While gun gurus endlessly argue their favorite caliber's perceived superiority, the most important factor in any armed confrontation — accurate shot placement — often gets short shrift.

proponents, of course, base most of their logic on the Philippine/Moro "results" where the .45 supposedly proved far superior to .38 caliber revolvers. Unfortunately, documentation, as opposed to legend, doesn't support this: The .45 didn't make much more of an impression on doped-up Moros than did the .38s.

Thus we move inevitably toward the conclusion that more important than anything else, if you don't hit your target, and he doesn't realize he's been hit, it probably doesn't matter what handgun you're using. I'd rather have Carlos Hathcock on my side with a blunderbuss than Joe Idiot with a sniper rifle.

The handgun is essentially a close-quarters defensive weapon, and unless you can convert it to fire missiles and carry \$20 million worth of attendant technology, it will never be an F-14 Tomcat. And though it can achieve impressive results in competent hands, no infinitesimal variations of caliber, bullet shape and velocity will transform a handgun into Death's own magic wand.

What technological improvements, do, however, is give you an edge — which may be the deciding factor that saves your life. It is not a guarantee, it's an insurance policy — no more, no less. If you were in a home-defense situation, you'd probably be content to take on a lone intruder with a Charter Arms Bulldog. On the other

## Marksmanship & Magic Bullets

hand, in a riot situation most people would probably trade those five rounds of .44 for 16 rounds of 9mm.

Two factors to consider are: Does a .45 make a .45 caliber hole? And how important is penetration? Several years ago, Ross Seyfried painted a Hensley and Gibbs semiwadcutter bullet and fired it into sand-impregnated gelatin. Upon retrieval, only the bullet nose was devoid of paint — the entire rest of the bullet, including the cutting edge of the wadcutter, was still in pristine, painted condition. In other words, in gelatin he ended up with the same results as he would have with a smaller caliber full wadcutter, because the bullet had "slipped" through the temporary cavity.

To my uneducated mind, the only conclusion is that a .45 is better than a .36 only if the bullet clips bone, artery, etc. In other words, it depends on *where* the bullet impacts on your adversary's body. In line with this thinking is the theory that people who employ the "stronger" caliber are often the ones who train harder, resulting in more hits per round fired — and possibly skewed statistics.

The latest genre of handguns is heavily inclined toward the .40 caliber variety, attempting to get velocity and magazine capacity without sacrificing too much caliber. This in itself is probably the ideal combination, but we won't know until there are several thousand case records.

Yes, technology has improved handgun bullet design and performance to a fine art. But as always, we tend to rely on technology to make up for operator inability. The difference in the .36-.45 handgun caliber range is probably so infinitesimal that unless we reacquire our forebears' art of shot placement in a fight, handgun caliber arguments are about as useless as a frog without a waterproof rear end. ✕

# SURVEILLANCE

## Pinhole CCTV Camera System

Complete pinhole system includes; 4mm pinhole lens, mini-CCD camera, mount, B&W monitor, cable, power supplies and a 24-hour time lapse VHS recorder. Retail \$3,650. **SALE \$2,495** (ship/ins \$35).

**Disguised cameras from \$495.** (Smoke detector, emergency lights, etc.)



**COVERT VIDEO SPECIALISTS**

Wireless Video Transmitters & Receivers. Call.

Complete CCTV system design and installation available worldwide.



## Match Box Transmitter

**TK-100 Tuneable FM Transmitter Kit\* with matching receiver \$199** (ship/ins \$7).

**TK-500 UHF Crystal Controlled Professional Transmitter Kit\* \$349** (ship/ins \$7). Available

on two frequencies. Extra lithium batteries \$8 each.

**Professional High Gain Two Channel Receiver \$1,200** (ship/ins \$20).

## Telephone Transmitter

**TK-200 FM Tuneable Transmitter Kit\* with tunable receiver \$199** (ship/ins \$7).

**TK-600 UHF Crystal Controlled Professional Quality Transmitter Kit\* \$399.** Two frequencies available. Works with scanner or professional high gain receiver.

**\*NOTICE: Transmitter kits require simple (10 minute) final assembly.**

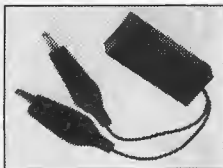

- **Body Wire and Receiver Set \$299** (ship/ins \$10)
- **Body Wire Detector \$695** (ship/ins \$10)
- **Complete Basic Countermeasures Kit \$1,495** (ship/ins \$35)
- **Tap Nullifier. Jams telephone taps. \$695** (ship/ins \$10)

## Audio Surveillance Kit

Includes;

Body wire and receiver,  
VHF crystal controlled  
Telephone recording system  
Mini microphone w/amplifier  
and 25' cable  
FM Match Box Transmitter Kit  
FM Telephone Transmitter Kit

Receiver for FM Transmitter  
Touch Tone decoder  
Call Logger  
Lineman's handset (telephone)  
Contact microphone  
Telephone Infinity Ear  
Taps & Bugs Video

Assembled in a briefcase. **\$1,495** (ship/ins \$25).

## Telephone Recording System

Complete system includes; extended play recorder, 140 minute cassette, power supply, telephone interface for standard single and multi-line telephones, alligator clip adapters for attaching the recorder anywhere along the telephone line. Includes everything you need to record your calls.



Starts and stops automatically. Voice activated. Optional "beep" mode. **EP-500 Telephone Recording System \$195** (ship/ins \$7).

Record for 12 hours with EPPI's **Professional Model Pro-12 Telephone Recording System \$399** (ship/ins \$19).

- **Call Logger II** - keeps an electronic record of all OUTGOING calls (phone numbers) made from any single line telephone. Even shows local numbers that your phone bill won't. Attaches anywhere along the line. **\$189** (ship/ins \$10).
- **Telephone Taps and Room Bugs.** How they're done and how to defeat them. Surveillance expert reveals trade secrets, step by step. Shows many of the actual devices. One hour VHS **\$49.95** (ship/ins \$4).
- **Israeli Instinctive Combat Shooting Method.** One hour step by step lesson. Filmed in Israel. VHS. Retail \$49.95 **Limited Offer \$29.95** (ship/ins \$3).



## KGB Photo Sniper System

Camera, shoulder stock, 300mm lens, filters, carrying case etc. A tremendous value. **Only \$599** (ship/ins \$25). This is THE system used by surveillance teams in former East Block Countries.



## Night Vision

### WARNING!

**Not all Russian night vision is equal. Don't get burned buying cheap junk or units that produce dangerous x-rays.**

- Binoculars
- Riflescopes
- Handheld viewers
- Complete camera systems

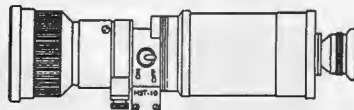

**Invest in quality at excellent prices. Call EPPI.**

NOTICE: These products are intended and sold only for the purposes of testing and experimentation and training in electronic countermeasures. Any other use may be illegal. FCC licensing may be required prior to assembly. Not to be used for surreptitious interception of oral communications. All equipment is sold subject to public law 90-351, title III, 18 U.S.C. Section 2511. All local, state, and federal ordinances, rules, regulations, etc. it is the sole responsibility of the buyer (not the seller) to consult legal counsel for interpretation of any laws applicable to the area of intended use.

**Catalog \$5**



## Surveillance/CounterSur.

**Hands-on Seminars**

Two days - held bi-monthly

**\$495**

**Call for dates and reservations**

**Executive Protection Products, Inc. - The Professionals**

1325 Imola Ave. W. #504S, Napa, CA 94559 **707-253-7142** FAX 707-253-7149 MC/Visa

# FASTER THAN A SWITCHBLADE!

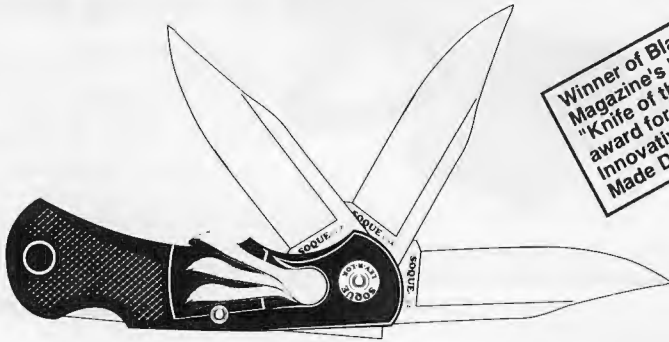

Winner of Blade Magazine's '93 "Knife of the Year" award for "Most Innovative American Made Design!"

## LEV-R-LOK™

At your dealer or order direct. Free brochure.  
VISA, MasterCard, Discover and Amex accepted.

Soque River Knives  
P.O. Box 880-SF  
Clarkesville, GA 30523  
706-754-8500 FAX 706-754-7263

**\$59.95** ppd

## Let the criminal become a statistic in a life threatening encounter

Use the Self Defense Training System by Reitz Industries to prepare for defending yourself in a life threatening encounter.



Earn points by hitting criminals • Lose points by hitting hazards

- 5 different 25" by 35" targets with combat situations
- Stickers to cover old holes so targets can be practiced on many times
- Scorecard to measure your increase in accuracy and system instructions

All this for only **\$9.99** per game plus \$2.90 for shipping.  
Or **\$39.95** for 5 games plus \$4.45 for shipping.

**ORDER NOW! 612-536-1576**  
Or send check or money order to Reitz Industries, P.O. Box 352 Hopkins, MN 55343

## COMMAND GUIDANCE

Continued from page 3

aircrew members, "several hundred" other U.S. POWs and several thousand South Koreans were sent to the Soviet Union. The report states that of 8,140 U.S. Body Not Recovered (BNR) cases, 5,945 are cases where the death was witnessed by repatriated U.S. personnel or otherwise documented, leaving 2,195 unaccounted for, of whom a significant number, apparently, disappeared into the Soviet Union. None of these have been repatriated.

The report is persuasive. It is obviously written by objective-minded, competent intelligence professionals and based on a large mass of documents (Russian and American) and interviews with numerous witnesses — American and Russian officers, former inmates of the gulag who met American pilots in the camps, former Chinese communist officers and so on. Of course there are no answers to the two ultimate questions: "What became of these men?" and, "If there are any survivors, who and where are they and when will they be repatriated?"

Table 1 on page 7 of the document lists nine USAF Korean War POWs on whom the Russian archives should have more information. Appendix D lists 4-1/2 single-spaced pages of other "outstanding questions." From Khabarovsk onward, the MGB (now KGB) had control of the prisoners, and the KGB is not cooperating. Murderers are generally unwilling to provide documentation of their own crimes.

The report does not address the issue of U.S. POWs retained by the North Koreans or the Chinese, and only tangentially refers to the thousands of South Korean POWs who were sent to the Soviet Union. Since North Korea and mainland China are still under unrepentant communist governments, even something approaching the limited Russian cooperation that resulted in this report is not to be hoped for from them, and the KGB probably has no more desire to talk about South Koreans in the gulag than about Americans.

What can be done? Mainly, members of Congress and ordinary concerned citizens should phone, write, and otherwise exhort the president to use the great leverage that the Russians' economic problems give him, to put pressure on Yeltsin to direct that the facts and records on U.S. Korean War and Vietnam War POWs be made public, and that any surviving POWs be repatriated. Given Yeltsin's apparently limited degree of control over the KGB, it might not work, but we have to try. We owe these brave men and their families no less. ✕



**5% STRENGTH  
MADE IN U.S.A.**

# BODYGUARD™

**STOP ATTACKERS  
COLD**



**BSD1... 1/2oz. Purse/Pocket Unit ... \$9.95**

**BSD2 ... 1/2oz. w/Holster ... \$14.95**

Range: 6-8 feet • 15 one second shots  
Height - 3 1/4" • Diameter - 7/8"

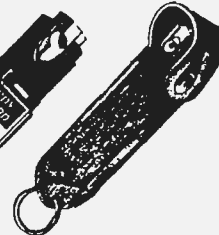
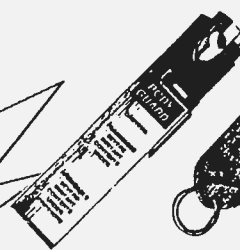

**BSD3 ... 3/4oz. Purse/Pocket Unit ... \$10.95**

**BSD4 ... 3/4oz. w/ Holster ... \$15.95**

Range: 6-8 feet • 20 one-second shots  
Height - 4" • Diameter - 7/8"

**THE ULTIMATE  
PROTECTION  
DEVICE**

**NEW**

## Alaskan Magnum

Alaskan Magnum is an effective easy to use repellent that can be carried by hunters, hikers, fisherman, backpackers, forest rangers, or anyone that is likely in encounter a violet attack. Utilizing the same active ingredient as our BodyGuard, Alaskan Magnum uses a 10% strength of oleoresin capsicum that is sure to knock down anything!

**BG2 ... Alaskan Magnum 9oz ... \$49.95**



**BSD14 ... 3oz. Fogger w/ Fire Master Top ... \$19.95**

**BSD15 ... 3oz. Fire Master w/Holster ... \$24.95**

Range: 20-25 feet • 5 one-second blasts  
Height - 6" • Diameter - 1 3/8"

**FREE Catalog  
with order!**

**BSD12 ... 3oz. Fogger Unit ... \$17.95**

**BSD13 ... 3oz. w/ Holster ... \$22.95**

Range: 15-20 feet • 5 one-second blasts  
Height - 5" • Diameter - 1 3/8"

## BODYGUARD 2000™ Personal Self Defense Keyring

BodyGuard 2000™ is the state-of-the-art self defense keyring. The BodyGuard 2000™ has an effective range of 6 feet and projects in a fog spray pattern. The BodyGuard 2000™ is refillable and gives you about 15 one second blasts.

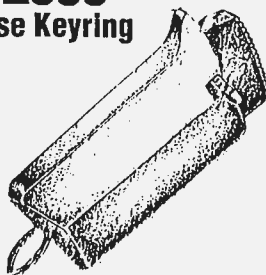

**BSD 2000 ... 1/2oz. Keyring ... \$17.95**

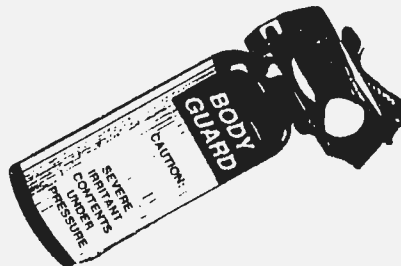

**BSD16 ... 9oz. Fogger Unit ... \$29.95**

Range: 20-25 feet • 8 one-second blasts  
Height - 7" • Diameter - 2"

**FOR M/C, VISA, AMEX, or C.O.D. CALL  
TOLL FREE: 1-800-628-9985 or write to:**

**Sonic Technology, Inc.**  
10105 E. Via Linda, Ste 103-261  
Scottsdale, AZ 85258

**ADD \$5.00  
SHIPPING**

Please Ship: \_\_\_\_\_

Name: \_\_\_\_\_

Address: \_\_\_\_\_

City: \_\_\_\_\_ State: \_\_\_\_\_ Zip: \_\_\_\_\_

## The Instantly Effective Non-Lethal Self Defense Weapon

BodyGuard is a unique new product using oleoresin capsicum (red pepper) as its active agent. BodyGuard is a formula designed to replace all other defensive tear gas aerosols and comes in sizes to fit most applications. BodyGuard acts as an inflammatory agent which swells the mucous membranes (eyes, nose, throat, and lungs). BodyGuard has been field-use proven superior to "Mace" and CS and CN tear gas in that it WILL control a drunk, psychotic, drug abusers as well as multiple attackers. BodyGuard is the perfect self defense spray!

**ORDER TOLL FREE: 1-800-628-9985**

# Second Amendment OP

by Jeff Nelson

## On Thanksgiving

weekend 1993, with Vice President Al Gore assuming his constitutional duties as presiding officer of the U.S. Senate, and with only the leadership of each party present, the House version of the Brady Bill was passed into law.

Brady is a done deal; it was signed by President Clinton the following Tuesday and goes into effect 90 days thereafter.

### What happened?

We all know that Brady will do absolutely nothing to control crime. We know that Professor

members are the most self-sufficient group he had ever run across. And that's only the 3.5 million gun owners that join the NRA. The remaining 56 million gun owners (and 16 million hunters) are out there going it alone, being blown away one at a time by the media who are subject to relentless attacks by the antis.

### Now is the time to turn this thing around.

First, join the NRA. Pick up the phone and call: 1-800-426-4672. If you are already a member, sign up your wife or girlfriend (NRA has two magazines... you get one, let her get the other).

Then, get three of your friends to join... along with their wives, girlfriends, etc. The NRA might have lost this battle, but believe me, without them, it would have been a lot worse.

All of the pro-gun groups, to a degree, are effective. The NRA, though, is the big guy. Give them all the membership numbers that you can.

Read their legislative writings. Write letters to your congressmen and to your senators.

Whenever an article or editorial appears in your local paper, sit down and write a rebuttal *that day*. The biggest trap we fall into in dealing with the media and elected representatives is that we expect them to be knowledgeable, and we expect them to be reasonable. There aren't enough brains in the world to staff all the newspapers with knowledgeable people. When they screw up, let them (and their editors) know. This is an ongoing responsibility. No one said that it would be easy. The alternative is to be in the position of getting into a public fight with a guy who buys ink

by the barrel. Not a good situation to be in.

Now for the really bad news. The Senate's version of the much ballyhooed Crime Bill includes something called the Feinstein amendment. This piece of legislation flat outlaws selected "assault rifles," their magazines and "copycats" thereof. Feinstein will "grandfather" in those firearms now privately owned and provide for a registration system for transfer from citizen to citizen.

Because of the copycat provision this amendment affects hundreds of rifles, though the sponsors are downplaying this by pointing to a list of some 600 guns that will not be affected — most are bolt-action rifles and side-by-side shotguns. Conspicuous by their absence on this list: handguns.

The Crime Bill still must be passed by a Senate-House conference committee, and then re-approved by both houses. The conference date is not yet set, but high-placed sources tell me that Slick Willie, Janet Reno, the directors of the FBI, BATF and Secretary of the Treasury will begin a nationwide carnival tour in late December or early January to stump for this bill. They will be stumping for the Feinstein amendment in particular and with great hype.

And this is only the beginning. Slick Willie stated in the 9 December 1993 issue of *Rolling Stone*, "We should have an assault-weapon ban." When asked if it was "conceivable that the country could entertain the possibility of banning handguns?" Slick responded, "I don't think the American people are there right now ... but we've got much more to do on this issue ..."

The antis are about to begin a feeding frenzy that would do a piranha proud. Your freedoms are in your hands and come in many small packages ... 29 cents at a time. ✕

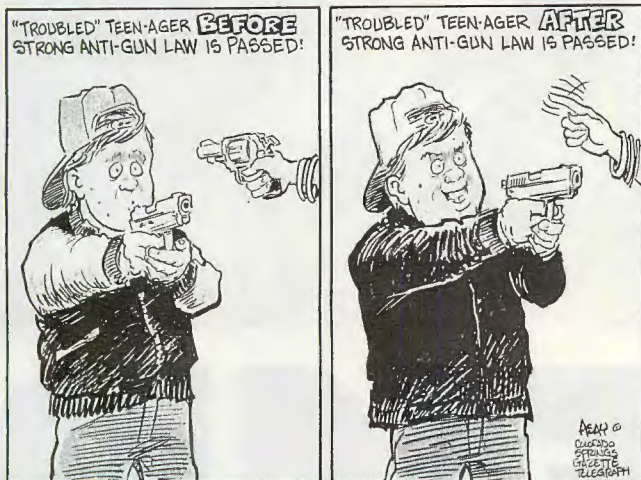

Gary Kleck, of Florida State University, has research that indicates law abiding citizens use a gun 2.5 million times a year to thwart crime... that law abiding citizens annually justifiably kill three felons for every one killed by a law enforcement officer.

Mao tells us that the guerrilla lives in the sea of the population ... dry up the sea and the guerrilla dies. The antis dried up the sea on us this time. For years, most of us, not needing anyone on our side, did nothing. Gun owners are, as a group, a very self-sufficient bunch. Professor Ed Leddy of the University of Wyoming did research in the mid-'80s and found that NRA

## Banning All "Assault Weapons"

**The United States Marine Corps** has a new machine gun. After more than a quarter of a century spent struggling with the M60 General Purpose Machine Gun (GPMG) and its numerous flaws and idiosyncrasies, the USMC has an excellent, battle-proven replacement that more than satisfies all of its requirements for a .30 caliber machine gun, exhibiting the highest possible levels of both human engineering and RAM-D (Reliability, Availability, Maintainability-

Durability).

Called the M240G, it is the ground version of the M240 coaxial (meaning that it moves in conjunction with the tank's main gun) machine gun mounted on U.S. Main Battle Tanks (MBTs). This, in turn, is the coaxial version of the well-known and highly regarded FN MAG (Mitrailleuse a Gaz: gas-operated machine gun) 58 GPMG. Produced in Belgium, India, Sweden, the United Kingdom and the United States (and with unlicensed copies manufactured at 205 Arsenal in Taiwan and by Chartered Industries of Singapore), more than one million of these machine guns have been employed by more than 100 countries throughout the world.

Except for client states, such as El Salvador and South Vietnam, who had no choice in the matter, only the United States, Australia, South Korea, the Philippines and Taiwan adopted the M60. It was not, however, the worst machine gun ever employed by U.S. armed forces. That distinction belongs to the dreadful French Chauchat Light Machine Gun (LMG) issued to the American Expeditionary Force during World War I. It's not even the second worst machine gun adopted by the U.S. military. That position is held by the caliber 7.62x51mm M73/219 coaxial machine gun. So, the M60 must be relegated to third place on any reasonable authority's list of the U.S. military's machine-gun fiascoes. (A few others deserving unhonorable mentions, in my opinion, include the .50-caliber M85 and the Model 1909 Benet-Mercie Machine Rifle).

The project that culminated in adoption of the M240G originated at the USMC Ground Weapons Division in Quantico, Virginia, about three years ago using FN MAG 58 hardware applied to the M240. It was concluded that this combination would constitute an excellent replacement for the M60, which did not perform well during Desert Storm. (Among its more blatant imperfections, long noted by me over the years, the M60E3's lightweight barrels slumped during sustained fire burst sequences.)

It was determined that the U.S. Army had enough M240s to permit the Marine Corps to replace all of the M60s in its inventory. These guns were then obtained through negotiations with the Army and subsequently sent to the USMC depot in Albany, Georgia, where the conversion will be effected.

Here then is an acquisition where, for once, the U.S. taxpayer really benefits. The guns were acquired without cost to the Marine Corps, and U.S. workers will be employed to convert the weapons into the M240G configuration. FN Nouvelle Herstal SA (Dept. SOF, rue Voie de



# SEMP

**Marines Replace**

**Much-Maligned**

**M60 With Battle-Proven**

**M240G**

**Text & Photos by  
Peter G. Kokalis**



# ER MAG



Above: USMC has adopted an excellent, battle-proven replacement for the severely flawed M60. The M240G, a variant of the highly regarded FN MAG 58 series, meets the highest possible standards for reliability and durability.

Marines intend to employ the M240G as a fire support weapon fired almost exclusively on a new, lightweight version of the M122 tripod onto which will be placed the newly adopted LTM-M122 flex mount — a lightened version of the FN soft mount as already used with the M240E1 machine gun mounted on the LAV.

Liege, 33-B 4040 Herstal, Belgium; phone: 32-41-40-81-11; fax: 32-41-40-86-79) has been contracted to provide small components required for the conversion. FN Manufacturing Inc. (FNMI, Dept. SOF, P.O. Box 24257, Colum-



bia, SC 29224; phone: 803-736-0522; fax: 803-736-9949) will be a subcontractor for the Technical Data Package.

The FN MAG 58 was the crowning achievement of FN's premier designer, M. Ernest Vervier. The FN MAG series is belt-fed, gas-operated and fires from the open bolt position. Headspace and timing are fixed. It is air-cooled and its 24.7-inch barrel is designed for quick-change by the gun crew. The M240G weighs 26.2 pounds with an overall length of 49.0 inches. Its adjustable gas regulator permits the cyclic rate to be varied from 750 to 950 rpm.

The M240G receiver is constructed in a manner similar to those of Browning machine guns. The steel side plates are attached to the bottom plate by means of rivets installed with an orbital riveter. The front is reinforced to accept the front block and gas cylinder, which are permanently mounted. Guide rails, which support the bolt assembly and piston extension during their reciprocating movements, are riveted to the side plates. The bolt's guide rails are shaped downward to drive the locking lever into engagement with the locking shoulder — also riveted to the side plates.

The right side plate is cut out for the retracting handle (the Belgian FN MAG 58 charging handle and pin have been adopted to replace the cable charging system used on the M240), and the bottom of the receiver body is cut away in front of the locking shoulder to eject empty cases. The spring-loaded ejection port dust cover found on the FN MAG 58 has been omitted. A notch milled into the receiver floor retains the recoil spring and guide rod. The rear of the receiver has been reinforced and slotted to accept the buttstock. The receiver's interior surface is chrome-plated to facilitate maintenance.

The piston, piston extension and bolt group have been taken from the Browning Automatic Rifle (BAR) — a weapon which has assumed a legendary status in the annals of Marine Corps history far beyond its real merit — with the exception of the locking action which has been moved from a recess in the top of the receiver to a locking shoulder on the receiver floor to permit feeding by belt from the top of the gun (the BAR was magazine-fed from the underside). The piston is chrome-plated and has a cup-shaped end. While it is more difficult to clean this type of piston head, it will operate longer without servicing and seems to provide a sharper initial recoil impulse.

The current piston assembly has a fixed piston. An earlier variant, found only on some FN MAG 58s, featured a floating piston. While they are interchangeable, the fixed piston employs a shorter firing pin. The piston extension is cut out to permit the empty cases to eject downward. At its rear is a massive piston post to which is attached the locking lever link by means of a removable pin. The firing pin is retained in the piston post by a roll pin which is not easily removed. The Israelis have improved this by use of a split-pin that can be removed without a punch.

The firing pin moves through a cut in the locking lever link into its channel in the bolt body. It is not spring-loaded. The locking lever link is connected to the locking lever by two non-removable pins. The front arms of the locking lever are pinned to the bolt body where they ride

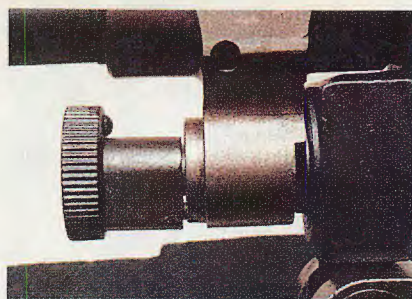

At present, the M240G gas regulator is that of the M240 — no gas is vented into the atmosphere and the barrel must be removed to adjust the three-position regulator.

and rotate in recesses on each side. The recoil spring and guide rod are housed within the hollow interior of the piston extension. Early versions of the FN MAG 58 used single strand recoil springs. All recoil springs in the MAG series are now of the multiple-strand type. Multi-strand springs avoid the "surg-ing" (wave movement) associated with high cyclic rates by increasing friction. These springs last longer and offer better performance under adverse conditions.

An actuator roller, which operates the feed system, is mounted on top of the bolt body. It is spring-loaded. If the top cover is closed with the bolt in the forward position, neither the roller nor feed channel will be damaged. In addition, the spring-loaded actuator roller acts as a self-timing feeder. If the roller is not in the feed channel as the bolt moves rearward, the second phase of the feed cycle will not take place. Thus, rounds can never be out of sync with the bolt movement. Try this sometime with the M60 and see what happens.

### Classical Gas

The gas regulator of the M240G and M240 is of a type commonly used in armored fighting vehicle applications. To prevent contamination of the vehicle's interior, no gas is vented into the atmosphere.

There are three regulator positions. To adjust the regulator, the barrel must be removed.

The M240G's air-cooled, quick-change barrel is 24.7 inches long and weighs 6.6 pounds with flash suppressor, carrying handle and gas regulator. At first, MAG barrels had radial cooling fins at the rear end, but this feature of dubious value was dropped early on. The four-groove rifling has a right-hand twist of one turn in 12 inches. The flash hider was developed by FNMI to accommodate the Marine Corps BFA (Blank Firing Attachment), which was already in inventory. More importantly, the new flash hider significantly reduces the flash signature and thus enhances the employment of Night Vision Devices (NVDs). It is a "birdcage" type with seven slots.

The chamber end of the barrel has two sets of external interrupted threads that

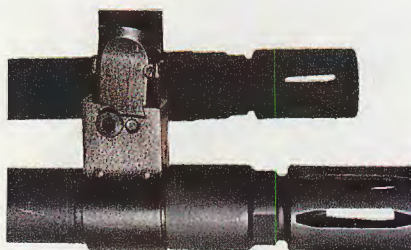

M240G's flash hider significantly reduces the flash signature and accommodates the USMC BFA.

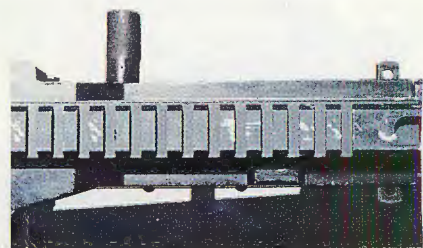

Experimental "Picatinny" scope rail mounted to the top cover of M240G used in Marine Corps test and evaluation of the weapon system.

mate with the barrel-locking nut threads on the receiver. To change the barrel, first retract the bolt and push the trigger mechanism's cross bolt to the right into the "Safe" position ("S"). Depress the barrel-locking catch button (located on the left side of the receiver), and at the same time rotate the carrying handle up to the vertical position without pulling up on the spring-loaded barrel nut catch. This will rotate the barrel's interrupted threads out of engagement with the locking nut threads. Move the barrel forward and lift it off. Replace in the opposite manner. Pull up on the barrel nut catch when you want to rotate the carrying handle into the vertical position for transport only. This method is taken from the Belgian FN Model D Browning Automatic Rifle, except that the direction of rotation has been reversed.

The front sight is a blade-type with a threaded base. The blade is screwed into a dovetailed block with heavy protective ears. Elevation zero is adjusted by screwing the blade down to raise the Mean Point of Impact (MPI) or up to

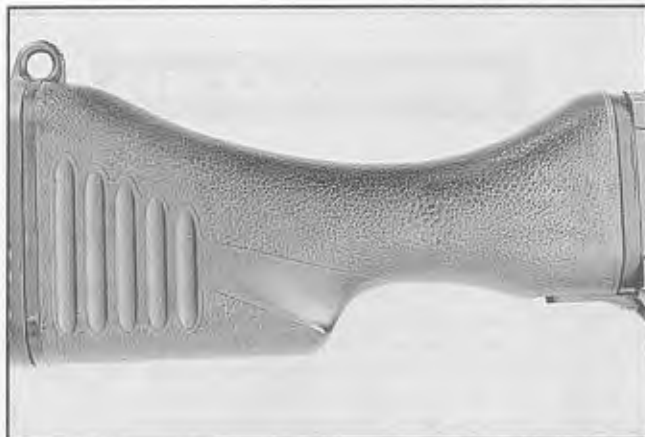

Royal ordnance black plastic buttstock will be used on the M240G because plastic is more easily decontaminated from NBC agents than wood. It will be equipped with steel FN hardware because the aluminum British buffer block will eventually crack.

## FLUID FIRING CYCLE

Some of the MAG series features are fascinating, but it helps understanding to summarize the gun's method of operation and firing cycle.

With the bolt retracted, the first round of a belt in the cartridge tray's feedway and the top cover closed, pressure on the trigger will drop the sear and release the bolt. The bolt's feed horn comes in contact with the base of the cartridge and moves it toward the chamber. The locking lever contacts the ends of the front guides inside the receiver and begins to move downward. The bolt chambers a round while the extractor slips over the rim.

At this point, the piston extension continues its forward movement and accelerates the downward swing of the locking lever until the face of the lever is in position in front of the locking shoulder. The system is now in battery. The piston extension keeps charging onward a short distance, causing the firing pin to protrude through the bolt face to strike the primer. The piston extension stops all forward travel when its shoulder strikes the face of the gas cylinder.

After the shot has been fired and the projectile passes the barrel's gas vent, some of the propellant gases pass through the vent into the gas regulator and cylinder to drive the piston and piston extension rearward. As the firing pin is withdrawn, the link connecting the piston extension and locking lever pivots upward. As the link lifts the locking lever away from the locking shoulder, the bolt's rearward travel is thus retarded and primary extraction is initiated. This system, taken from the Browning Automatic Rifle (BAR), insures particularly smooth and effortless functioning.

Free of the locking shoulder, the locking lever pulls the bolt rearward, completing extraction of the fired case. The empty case is tipped downward and out through the bottom ejection slot by the bolt's spring-loaded bump ejector. As the recoiling components continue their rearward travel, the recoil spring is compressed. Rearward travel ceases when the end of the piston extension strikes the buffer. If the trigger has been released, the piston extension will be caught by the sear and the bolt will remain extracted. If not, the firing cycle begins again.

— P. G. K.

lower the MPI, after the retaining stirrup has been lifted. This can be done only with a special spanner wrench issued to armorers. The M240G is usually zeroed at 200 meters.

Horizontal zero is altered by use of the same tool. To move the MPI to the left, the sight block must be slid to the right in its dovetail. Securing screws on each side are alternately loosened and tightened. Front sight adjustments are always in the opposite direction of the desired change. While some have criticized the lack of zero adjustment at the M240G's rear sight assembly, weapons with quick-change barrels should always be zeroed at the front sight so that both the primary and spare barrels shoot to the same MPI. This was a major failure of the M60's design.

The folding-leaf rear sight provides a peep aperture in the down position for ranges from 200 to 800 meters in 100-meter increments and 800 to 1,800 meters in the up position. The rear sight leaf is hinged to a base with protective ears that is integral with the receiver's upper forging. With the rear sight folded, the sight radius is 33.4 inches (848mm); when raised the sight radius is 30.9 inches (785mm).

Both front and rear sight assemblies are identical to those of the FN MAG 58 and the Marines' M240E1 (a version with spade grips which is mounted on the LAV) and are thus already in the system.

An FN MAG 58 bipod has been attached to the end of the gas cylinder about 12 inches in back of the muzzle. Its aluminum legs, with their distinctive splayed appearance,

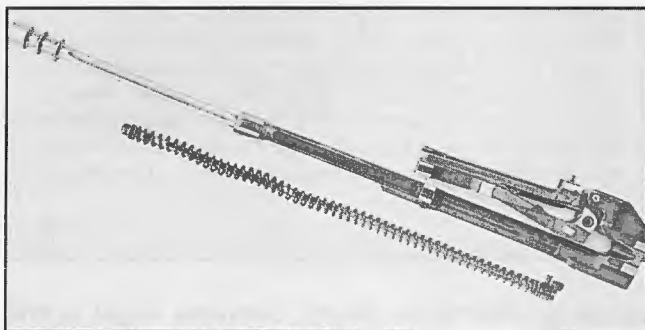

M240G piston, piston extension and bolt group have been taken from the Browning Automatic Rifle (BAR). Recoil spring is of the multiple-strand type, which lasts longer and offers better performance under adverse conditions.

## M240G's SLICK FEED

The feed mechanism operates in two distinct phases and feeds from the left. When the bolt begins its forward travel, the spring-loaded feed roller on top of the bolt carrier moves in the straight part of the top cover's feed channel rail and the feed pawls remain stationary. The first round is chambered during this movement. During the second half of the forward movement, the feed roller reaches the bend in the feed channel rail, forcing it to pivot to the right on its axis. This movement actuates the feed link, pushing the upper feed slide to the right, taking the front and rear feed pawls with it. At the same time, the lower feed slide moves the next cartridge to the right until it's in contact with the sloping face of the cartridge guide pawl. With its springs compressed, the inner feed pawl rides to the left over this cartridge. All three pawls are engaged behind the cartridge when the bolt carrier ends its forward movement.

In the second phase, the feed roller's rearward movement pivots the feed channel rail on its axis to the left. The upper feed slide, with its front and rear pawls, now moves to the left. The lower feed slide, with the inner pawl, moves to the right. The inner feed pawl pushes the cartridge on top of the bolt, as the cartridge guide pawl rises into position behind the inner pawl. The front and rear pawls are now riding over the third cartridge moving into position to recommence their cycle. The pawls do not move as the feed roller travels rearward down the straight portion of the feed channel rail. As the bolt clears the feed tray, the second cartridge takes its final position in preparation for the cycle's repetition.

Thus, each set of pawls acts, in turn, as feed and stop pawls while the cartridge slides halfway across with each forward and rearward motion of the bolt carrier. This method, adopted from the German World War II MG42, produces a smooth belt flow instead of a series of herky-jerky movements. A similar system was employed on the M60. The feed channel rail, feed link and both feed slides are chrome-plated. The top cover body is an anodized, high-grade aircraft aluminum casting. It's held to the receiver by a spring-loaded latch on each side. All M240(G) top covers produced by FNMI have steel pins and rollers, instead of the aluminum pins found on Belgian-produced MAGs.

Most FN MAG 58/M240 feed trays are chrome-plated with the cartridge stop (configured for U.S. M13 disintegrating links) riveted in place. More recent M240 feed trays feature a stainless-steel unitized investment cast construction. These new trays reduce link wear at the feed slot, preclude the loosening of the cartridge stop rivets, and eliminate the need for chrome-plating and end failure of the tray's ears.

— P. G. K.

cannot be adjusted for height. Command height is thus fixed at 10.25 inches. The legs can be folded back — for carrying or use as a crude forearm — and secured in slots under the receiver by their hooks and a spring-loaded catch. There is a possibility that a forearm might be added to the

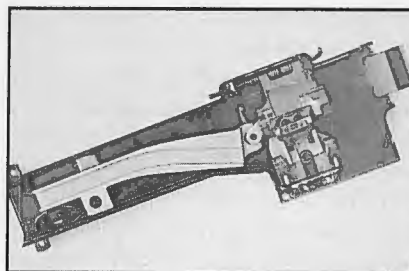

FN MAG 58 feed mechanism was adopted from the German World War II MG42 and produces a smooth belt flow instead of a series of herky-jerky movements.

the gas cylinder head until it's flush. The bipod can then be rotated enough to clear the gas cylinder's retaining lugs. While I recommend this procedure because considerable carbon fouling accumulates in this area, I'm sure the Marine Corps will not permit the gun crews to do so.

The trigger housing is anodized aluminum. It has a removable trigger guard. The trigger mechanism is exactly that of the MG42 with the addition of an anti-runaway device. The cross bolt safety operates directly on the sear and can be manipulated only when the gun is cocked. Pushing the cross bolt all the way to the right will expose the letter "S" ("Safe") and engage the safety catch against the heel of the sear. Moving the cross bolt all the way to the left will expose the letter "F" ("Fire") and disengage the safety catch from the heel of the sear. There is no provision for semiautomatic fire. Trigger pull weights vary from eight to 14 pounds.

### Squeezing Off A Shot

Because of its high rate of fire, the MG42 trigger mechanism incorporated a unique sear trip which was wisely retained on the entire FN MAG series of machine guns. The sear trip is spring-loaded and attached to the top of the trigger. The front of the sear passes through this sear trip and a T-bar at its end restricts the sear trip's forward rotation. When the trigger is pulled, the sear trip descends, allowing the front of the sear to rise while the rear end is lowered, releasing the piston extension. As long as the trigger is held back and ammunition remains, the piston extension/bolt group will continue to reciprocate back and forth. When the trigger is released, its front end rises, taking with it the sear trip as well as the front end of the sear. As a result, the rear end of the sear is lowered even farther. The sear trip now projects into the piston extension's path of travel. The piston extension's heel shoves the sear trip rearward. This frees the front end of the sear and



M240G folding-leaf rear sight provides a peep aperture in the down position for ranges from 200 to 800 meters in 100-meter increments.

M240G during the enhancement program to assist in moving the weapon when it is hot from extensive sustained firing.

The bipod can be removed from the gas cylinder by inserting a punch through the hole in its head and tapping the roll pin in

the gas cylinder head until it's flush. The bipod can then be rotated enough to clear the gas cylinder's retaining lugs. While I recommend this procedure because considerable carbon fouling accumulates in this area, I'm sure the Marine Corps will not permit the gun crews to do so.

The trigger housing is anodized aluminum. It has a removable trigger guard. The trigger mechanism is exactly that of the MG42 with the addition of an anti-runaway device. The cross bolt safety operates directly on the sear and can be manipulated only when the gun is cocked. Pushing the cross bolt all the way to the right will expose the letter "S" ("Safe") and engage the safety catch against the heel of the sear. Moving the cross bolt all the way to the left will expose the letter "F" ("Fire") and disengage the safety catch from the heel of the sear. There is no provision for semiautomatic fire. Trigger pull weights vary from eight to 14 pounds.

### Squeezing Off A Shot

Because of its high rate of fire, the MG42 trigger mechanism incorporated a unique sear trip which was wisely retained on the entire FN MAG series of machine guns. The sear trip is spring-loaded and attached to the top of the trigger. The front of the sear passes through this sear trip and a T-bar at its end restricts the sear trip's forward rotation. When the trigger is pulled, the sear trip descends, allowing the front of the sear to rise while the rear end is lowered, releasing the piston extension. As long as the trigger is held back and ammunition remains, the piston extension/bolt group will continue to reciprocate back and forth. When the trigger is released, its front end rises, taking with it the sear trip as well as the front end of the sear. As a result, the rear end of the sear is lowered even farther. The sear trip now projects into the piston extension's path of travel. The piston extension's heel shoves the sear trip rearward. This frees the front end of the sear and

permits the sear spring to drive the rear end of the sear upward to grab the piston extension with full face engagement in one sudden, sharp movement.

The sear trip fulfills two important functions. It

keeps the sear's bents in a low position except at the final moment of engagement with the piston extension, which reduces wear and chipping on the mating surfaces. It also prevents the trigger mechanism from being placed on "Safe" when the piston/extension bolt group is forward, as the sear could be damaged if the operator attempted to retract the bolt with the cross bolt on the "Safe" position.

An anti-runaway device added to late-model FN MAG 58s and all M240s has been retained on the M240G. It consists of a sear with two bents (or "beaks") mated to a piston extension whose sear notch has been modified to accept the double-beaked sear. Both the double-beaked sear and the modified piston extension can be interfaced with the older components.

## FAST FIELDSTRIPPING

It takes no more than 10 seconds to fieldstrip an M240G. First, lift the top cover, remove the belt and clear the weapon. Ease the operating parts forward by holding one hand on the retracting handle while you pull the trigger with the other. Remove the buttstock by depressing its spring-loaded release latch on the underside. Lift it up and away from the receiver. Push in and up on the guide rod and withdraw it and the recoil spring. Pull back on the retracting handle with the muzzle tilted upward and the piston, piston extension and bolt group will slide out the rear of the receiver.

The bolt group can be easily separated from the piston by just pushing out the locking lever link's retaining pin. The trigger group and top cover can be removed from the receiver body by depressing the spring on their retaining pins and pushing out the pins. Remove the barrel in the manner already described. Rotate the gas regulator nut counterclockwise until it separates from the gas regulator. Push the gas regulator off of its bushing on the barrel.

No further disassembly will probably be permitted by operators. This weapon is gas-operated and requires the same degree of cleaning and maintenance associated with machine guns that operate by this means, such as the M60 and PKM. Lubricants should be kept out of the gas cylinder and off the piston and gas regulator and plug. Reassemble in the reverse order.

To load the M240G, retract the bolt, place the system on "Safe," leave the top cover down, and insert a belt from the left side until the first round butts up against the cartridge stop.

An alternate method of loading is to squeeze the top cover's two spring-loaded latches inward and rotate the top cover upward to the vertical position. Retract the bolt and place the system on "Safe." Place the belt, with the open portion of the M13 links down, across the feed tray with the first round resting against the cartridge stop. If you are firing from the bipod, rotate the gun clockwise so the belt will remain in position and gently close the top cover. Slamming the top cover down with an iron fist looks professional — to amateurs — but only hastens damage to the top-cover latches.

Belgian, British and South African SOP specifies that the MAG be carried with the bolt forward and a belt in the feedway. The weapon must then be cocked first to bring it into operation.

— P. G. K.

## M240G SPECIFICATIONS

- Caliber:** ..... 7.62x51mm NATO  
**Operation:** ..... Gas-operated with an adjustable regulator; locked breech; fires from the open-bolt position; fixed headspace and timing.
- Cyclic rate:** ..... 750 to 950 rpm.  
**Feed:** ..... Belt-fed from the left side; M13 disintegrating metallic links.
- Weight, empty:** ..... 26.2 pounds.  
**Length, overall:** ..... 49.0 inches.  
**Barrel:** ..... Air-cooled; quick-change; 6.6 pounds with flash suppressor; 4-groove rifling with a right-hand twist of one turn in 12 inches.
- Barrel length:** 24.7 inches.  
**Sights:** ..... Blade-type front sight with protective ears; adjustable for windage and elevation zero. Folding-leaf rear with peep aperture and protective ears; ranges from 200 to 800 meters in 100-meter increments in the down position and 800 to 1,800 meters in the up position.
- Finish:** ..... Steel parts either phosphate-finished or chrome-plated; aluminum components black anodized.
- Manufacturer:** FN Manufacturing Inc., Dept. SOF, P.O. Box 24257, Columbia, SC 29224; phone: 803-736-0522; fax: 803-736-9949. FN Nouvelle Herstal SA, Dept. SOF, rue Voie de Liege, 33-B 4040 Herstal, Belgium; phone: 32-41-40-81-11; fax: 32-41-40-86-79.
- T&E Summary:** Battle-proven machine gun series — more than one million employed by more than 100 countries. Highest possible RAM-D levels (more than 26,000 MRBF). Together with the M240 and M240E1, it provides the USMC with a family of MGs which are completely interoperable and will greatly simplify logistics, training and maintenance. Far superior to the M60 GPMG it replaces.



M240G, fieldstripped.

The MAG series' great reliability is in a large measure due to components never seen. Hidden within the M240G's distinctively shaped black plastic buttstock is a truly suc-

Continued on page 64

## SPLAT Simulates Real-Life Ops For

# BEST LITTLE WA

**My sight picture** was perfectly aligned with *SOF* Publisher Robert K. Brown's solar plexus as I squeezed the trigger of a loaded 9mm Colt.

Thinking of the thousands of liberals, anti-gun activists and assorted ATF brass who would be cheering me on, I completed the squeeze and the pistol went off with a gratifying boom. Brown reeled under the impact as the round hit, but did not go down; so I shot him again. Another good hit, and red was showing on his shirt where the bullets struck, so I raised my muzzle and savored his agony. Unfortunately (for his enemies), the pain was not great, and the Simunition FX bullets I was using did not even penetrate his clothing. Too bad.

Rick Huffman, president of Practical Defense Training Technologies (PDT), in Ukiah, California, provided the pistol, ammunition (see sidebar) and opportunity for me to pop RKB in a shooting house of Huffman's own design. Called the SPLAT (Specifying Projectile Low-energy Ammo Training) Arena, the patent-pending portable range is the result of seven years' development and refinement and, combined with Simunition, provides the capability for exceptionally realistic and safe training.

Huffman has combined 10 years' experience as a personal protection specialist with a couple of years in architectural classes and an enormous amount of thought, to create an affordable, portable, versatile and simple-to-use facility. Designed primarily for law enforcement personnel, the system has obvious military and security applications as well. It is not intended for casual or recreational use, but for serious training by professionals.

The SPLAT Arena is a prefabricated plywood building 24 feet wide by 32 feet long. It does not have a roof, but the top and exterior windows are covered with a heavy-duty polyester screen to contain projectiles. Interior walls can easily be adjusted to task-specific requirements or to change



SPLAT Arena allows training with your own weapon in realistic, interactive scenarios where only hits count and where great care has to be taken to avoid hitting a hostage.

scenarios for generalized practice. Furniture can be placed inside for the same purposes.

At a total weight of 3,700 pounds, the whole package fits on a single trailer and can be erected in three hours by two men, or two hours by four men, indoors or outdoors. Targets can vary from silhouettes, to dummies, to real people, and video monitors can be fitted to record the action for critiques/debriefs. Low-light shooting conditions are possible in the

Next best thing to being there, SPLAT Arena hones realistic urban combat skills unlike any other system in its price range.



# R-HOUSE



Text & Photos by  
Robert MacKenzie

arena by simply covering it with a tarp, and installation of a sound system will provide background noise to further simulate real-life operations.

Safety procedures, especially important during training exercises, are enforced by the arena's design. Since personal pistols are used (easily modified on site by the replacement of the barrel with one which will accept *only* Simunition), safe-handling mistakes with unfamiliar weapons are avoided. Eye, face, and throat protectors definitely need to be used, and overalls are recommended, although ordinary street clothes can be worn.

Since the impact of a Simunition round smarts a bit and leaves a welt — this writer took a hit on a T-shirt-only protected stomach in the interests of journalistic accuracy — light body armor is also suggested. Helmets with face shields, or gas masks, provide more than adequate protection for the head and face. Since training should be conducted in the same gear as is used in real life, the user of the SPLAT Arena can outfit himself accordingly.

Beginners as well as more advanced shooters can improve not only individual firearm skills, but also tactics, entry techniques, teamwork with partners, and techniques

**Difference between Simunition FX and live rounds is that wounds heal almost instantly; between using Simunition FX and paint balls is that Simunition is fired from your usual service weapon — important if you train like you fight.**



for confrontation with armed or unarmed live opponents, in an enormous variety of situations. As a complement to live-fire training, the system far surpasses paint or blank ammunition. Of course, these same things can also be practiced in conventional shooting houses, but the low cost (\$19,500 including trailer) of PDT's SPLAT Arena, and the system's portability, make it especially useful for

## SIMULATED AMMUNITION THAT WORKS

Simunition FX is a new category of training ammunition developed three years ago by SNC Industrial Technologies Inc. of Ottawa, Canada. The concept complements live firing with training which far surpasses that possible with either paint balls or blank ammunition. A major advantage is that shooters use their own guns, rather than paint guns or training-specific weapons.

Now available in .38/.357 and 9mm calibers, Simunition FX rounds are designed to fit in the user's own weapon after installation of a simple conversion kit to ensure that live ammunition cannot chamber unless forced in, and even then a real bullet will not travel through the barrel. These kits, in the form of a special barrel for pistols, safety rings for chambers of revolvers, and a bolt for SMGs, can be fitted in minutes by the user. Magazines and speed loaders will function with Simunition as they would with real ammo.

FX projectiles are hollow plastic, containing a red detergent-based (so it washes out, of course) marking compound which leaves a distinct splash when the round disintegrates on impact. Both 9mm and .38 rounds have a muzzle velocity of 400 fps, give a 6-inch group at 25 feet and travel a maximum distance of 330 feet. They do not penetrate ballistic gelatin, or T-shirts — but eye, face, and throat protection is absolutely essential, especially when exercising against similarly armed opponents.

For details on SNC's Simunition FX, or their other training ammunition, call 1-800-465-8255 in the United States or 613-789-7010 in Canada. Orders for ammunition and conversion kits can be placed through their U.S. distributor, DCG Police Supply, in Menlo Park, California, at 1-800-998-7007.

— R. M.

realistic, practical training. A complete information package can be obtained by contacting PDT at: Dept. SOF, 541 South School St., Suite 71, Ukiah, CA 95482; phone: 707-462-7541.

*Major Robert MacKenzie is an SOF Contributing Editor for unconventional operations.* ☒



Above: Aerial view of the "Tower" with Thunderville in background. Tower is live-fire facility holding Dante's assortment of realistic scenarios for unwary student. Photo: courtesy Thunder Ranch



Thunderville, Texas: Population 0. The size of a city street, "Hogan's Alley" facility provides background for wide selection of live-fire, armed-confrontation scenarios. Photo: Bill Burris

# WORLD-CLASS THUNDER RANCH

## Shoot-Outs OK At This Corral

by **Bill Burris**

It was recently my privilege to attend the first firearms class conducted at Thunder Ranch. Located in Mountain Home, Texas, Thunder Ranch is the brainchild of Clint Smith, well-known to thousands of students from his endeavors at Gunsite, the Heckler & Koch Training Division, and International Training Consultants.

Widely respected for his no-nonsense, dynamic training style, Clint and his wife Debbie have, over the last 10 years, toured nearly every state in the union conducting firearms training — and developed a large following in the process. Now Clint has taken the next logical step in his career by establishing his own training center.

As any experienced firearms instructor will tell you, inadequate facilities can be a limiting factor in any training program. The facilities at Thunder Ranch present no such obstacle, as they are the most impressive I have ever seen. The scope and quality of the facilities have to be experienced to be appreciated, but it is my opinion that Thunder Ranch will become the standard for comparison in firearms training centers.

Five main ranges are spread over 2,400 acres and are



Thunder Ranch proprietor Clint Smith gives defensive pistol class that includes review of relevant human physiology. Photo: Bill Burris

specifically designed to accommodate various phases of pistol, shotgun, rifle and submachine gun training. These ranges sport features which include barricades as well as stationary, turning, "wobbling," resettable armored, hostage, "charging" (yes, they *charge* you) and "running" (these move at high speed across the backstop area) targets. The rifle range is 300 yards deep to the berm, and serves as a base for field fir-

ing out to 1,000 yards, with an impact safety area 2 miles deep by 2 miles wide.

"Thunderville" is a life-size rendering of two sides of a city street, what we commonly refer to as a "Hogan's Alley," but on a grand scale. This city street features 60 moving target options, all run by a computer that controls targets, lights, doors, timing and "applications." Clint describes Thunderville as "a very high speed obstacle course and decision-making shooting simulator, which can be set to work at night and give representations of being on fire."

### Fast (And Right) Decisions

The "Tower" is a four-story building that allows fire from, into, or inside the structure. Bullet traps inside the Tower back a variety of multidimensional targets that react to well-placed gunfire. Just as in the real world, accurate fire is required to incapacitate your target: "Spray and pray" shooting won't cut it. Tower exercises can commence with entries from the ground up, the top down via ladder, or somewhere in the middle after rappelling. Students negotiate numerous stairwells, hallways, landings and rooms under challenging circumstances that involve shoot/no-shoot decisions while maintaining a realistic dialogue with the "people" they encounter along the way. Just as in real life, shooters may find themselves juggling multiple problems while coping with events designed to distract and complicate the mission.

Imagine, for example, meeting an armed adversary in a confined space. You've got the "drop" on him, and order him to put his hands in the air. His response does not reflect a spirit of cooperation, and will, sooner or later, force a decision from you. While you maintain control of this threat, your back is exposed to whatever terrors the Tower has to offer. The air is pierced by alarms and intermittent strobe lights. As the room lighting grows dimmer, so do your prospects for a happy conclusion to this encounter. And this is just one of several problems you must solve every time you enter Clint Smith's high-rise of tactical delights.

The facilities already mentioned put Thunder Ranch in a league of its own, but incredibly, there is more. The "Terminator" is Clint's expression of the ultimate live-fire fun house. True to form, everything really is bigger, and better, in Texas. This free-span building is 70 feet by 40 feet and is separated into two sides, both containing numerous rooms, hallways and doors. Movable walls allow at least 200 varying floor plans. Targets are multidimensional as in the Tower and respond to *accurate* gunfire. Enhancing the versatility of the Terminator is a catwalk that allows in-



The "Terminator" back-to-back indoor simulator's large size and movable walls allow hundreds of conceivable floor plans for live-fire training scenarios. Overhead catwalk (inset) allows instructors to observe students as they shoot their way through various tactical problems.

Photo: courtesy Thunder Ranch; Inset: Bill Burris

structor observation of ongoing exercises. All persons entering tactical simulators at Thunder Ranch are provided with body armor.

Accommodations at the ranch are excellent. Classrooms are spacious and comfortable, as is the dining area. First-rate bathroom and shower facilities round out the amenities, making it enjoyable for camping during your stay.

As important as these sophisticated range features are, the core of a successful training program lies in the teaching skills of the faculty. In this regard, Thunder Ranch also excels. The staff boasts an impressive background of military and law enforcement experience, both as participants in actual operations, and as trainers. A sense of professionalism is evident throughout Thunder Ranch.

Instruction is straightforward, realistic and reinforced during live-fire exercises. One thing you won't have to worry about is keeping busy. Clint, as his students will attest, abhors "down time." Training is skillfully orchestrated so that the student is not required to spend time idly awaiting a turn in shooting simulators or other exercises requiring one-on-one instruction: Virtually all the student's time is spent in active training.

As a measure of this principle, during my class, "Defensive Handgun II," I consumed 2,000 rounds of ammunition in five days. By comparison, I've completed courses at other major schools which consumed only a quarter of this amount of ammunition in a similar time. Although this is a considerable volume of live fire, there is no "shooting for shooting's sake." Every exercise serves a purpose and hones a skill — and every round is expected to hit a target.

Continued on page 65



# EXPECT

# NO MERCY

*SOF readers will recall earlier Balkan reports regarding Nick "Zeljko" Glasnovic, the Croat-Canadian commander of the King Tomislav Brigade in Tomislavgrad, Bosnia.*

*Colonel Glasnovic has an identical twin, Joe "Davor" Glasnovic, who was held in Serbian prison/concentration camps for 15 months. As this story reveals, his ransom and release in August came none too soon.*

**Joe "Davor" Glasnovic** was born in Bihac, Bosnia, and emigrated to Canada at age 6. Incensed when Serbian atrocities attracted worldwide condemnation, he joined the Croatian army. He was captured on patrol 4 May 1992 and survived 15 months of unconscionable abuse by his Serbian captors.

Davor Glasnovic arrived in Zagreb, Croatia, in December 1991. In January 1992 he went to Osijek for three weeks' infantry training, and from Osijek to Ivanic Grad, then to the battalion depot in Kumrovec, Croatia, for final advanced infantry training. He returned in April to Bosnia-Herzegovina near Tomislavgrad, to a frontline village, Suica. The conflict there was characterized by skirmishes between scouting parties and patrols of Serbs and Croatians.

In interviews from hospitals in Croatia and Canada,

---

## **Beatings, Torture, Starvation Routine For Croat POW**

**by Robin Anthony**

---

Davor told *SOF* correspondent Robin Anthony the story of his capture, imprisonment and ransom:

"We got in at 0300 one morning and at 0500 we were told to go on patrol. We were to maintain radio communication and return at 0800. The patrol was made up of 26 men drawn from different units and assembled at the last minute. Our column was about 400 meters long, and I was the last man, carrying an RPG and an FAL rifle. We mined the road as we went.

"We lost radio commo, and made contact with Serbian

forces at about 0830 near a small village east of Suica called Ravno, 10 kilometers inside enemy territory. Suddenly a Serb ammo truck struck one of our mines and we followed up this opportunity by firing an RPG at it. Then a Serb territorial defense fighter arrived on a tractor and began firing on our forces. Two Croatian snipers soon cut him down. Half an hour later, a Serb APC showed up with a truckload of Yugo-Serb infantry.

"Croatian snipers shot at the truck, killing the driver and passenger. The soldiers in the back were being peppered by our forces and some were hit but many escaped into the woods. The APC drove into the woods also. The Chetniks regrouped, formed a line of skirmishers and counterattacked. They were firing high, and branches were snapping over our heads.

"There was a lull in the fighting about 0930, but we still were without communications. The Serbs increased their fire from above, and rounds started snapping over our heads from the left flank — we were gradually being encircled. Unfamiliar with this wooded terrain, we started to disengage and withdraw. During the withdrawal five of us became separated.

"I picked a position along the road and waited for an RPG target. About 1330, a Serb sniper hit me with an AP round in the hip. I was immobile. One Croat soldier tried to help, but I waved him off, as it was hopeless. The terrain was primeval, rocky and steep. Within three minutes 12 Serbs came and captured me.

"Soon eight more came. They thought I was my brother Zeljko, commander of the King Tomislav Brigade. They cut off my left ear. I had Australian currency and \$100 Canadian, which they looted. My pelvis was shattered and the femur severed. They took my pants and American boots; I was in only my underwear and a sweater. My hands were tied, and for 20 minutes they took turns dragging me across the rocky terrain. I still have scars on my legs from this 'Laredo rubdown.'

"Lying with my hands tied in front, they made me raise my hands above my head, then broke my ribs by kicking me: both sides — four ribs on the right

and three on the left. I was spitting blood for three weeks.

"The Serbs had at least 10 killed, while we had three missing without a trace, and myself wounded.

"I was taken to Kupres where a Serb taunted me by slicing tissue from my nose until the military police chased him off. The locals wanted to slaughter me, threatening to impale me and roast me alive. This was not an idle threat.

"Next they took me to Knin. I was fitted with a cast from my toes to my abdomen. On the 12th day, they blindfolded me and threw me into an APC. After 20 minutes the APC stopped, and we were transferred to trucks. The Serbs formed

a gauntlet, beating us with sticks and rifle butts. Because of my cast, I could lie down, but the others had to kneel all the way. The beatings never stopped until we arrived at Gradiska eight hours later. We had no water. One guy died on top of me, and I almost suffocated. Another man died in another truck.

"They then took us to the hospital in Banja Luka where I was in the holding area for one month. They hit me in the back of the head, put out a cigarette on my hand and smashed me between the shoulder blades with a rifle butt. One guard really let a prisoner have it with a rifle butt, swinging it like a baseball bat. This prisoner was in the bed next to me, bleeding from internal injuries. When he lowered himself to use the bed pan, he died. During the month that I was there, I was told that in the other jail, at the old hospital, they murdered 12 prisoners.

"Once they took us out, one guard punched me in the kidneys and the nape of the neck. He knew all the pressure points. When he hit me in the neck I got a jar to the spine like an electric shock. He punched me repeatedly in the jaw and the neck, about twenty times, while another guy whaled away at me with a short wooden bat on the back and the buttocks. I was ready to black out.

"I was there one month, then taken to Manjaca POW camp. I wasn't beaten there, but we were starved. People were constantly fainting from hunger. The Red Cross started monitoring conditions, or we would have all died. I didn't have a bowel movement for 23 days, and one Muslim went for 51 days without a bowel movement.

"To the left of my cell was solitary confinement, where beatings occurred every night and day. They lasted 20 minutes. Before the Red Cross came, the Serbs washed the blood off the walls. Some men were beaten to death — I personally know of a Croatian named Bender and a Muslim named Filipovic.

"On 7 August, 23 buses arrived with 1,300 prisoners from Omarska. They were badly beaten en route — having to kneel as they were beaten with ax handles and chains. Six POWs were dragged off dead, and four were dragged off badly beaten, but still alive. The Serbs jumped on their chests and then slit the throat of each man.

"They always presented me as a mercenary. Ninety-five percent of the POWs there were doctors and professionals who had been imprisoned to avoid later trouble from intellectuals. They wanted Manjaca to appear as a POW camp, when it really was a concentration camp.

"After a month we thought we were being taken to a Serbian army detention center for pretrial hearings. Serbian army personnel there told us that upon arrival we would be exchanged for Serb prisoners. We knew better. En route they stopped for us to 'take a leak,' but we had to stand and face a wall with our hands above our heads while they kicked us for a half-hour.

"In our new location, psychologically, the first month was the worst. Supper was three spoons of rice and a slice of bread. The guards said, 'Don't eat until we tell you.' We would wait and wait, and after about three hours we would dare to knock on the door to ask if we could eat, and they would laugh, and say, 'Not yet, don't eat without us.'

"Twelve months later I was housed with about 60 hardcore criminals. Serbs. Between them they had murdered 900-1,000 Croat and Muslim civilians, but were only charged with killing other Serbs. One Serb had killed 135



Davor Glasnovic shortly after enlisting in Croat army (above) and captured on videotape during his imprisonment (left). Photos: courtesy Neda Glasnovic

Muslims, but was brought to jail because he killed a family of Serbs.

"The first month it was hellish. There was constant verbal abuse, and they beat the three Muslims in my cell every day. The following two months were hideous. To this day I ask myself how I endured it physically and psychologically. My leg was broken, and I was on crutches, but I had to stand while they beat me.

"My last month and a half was also difficult. I was transferred to a civilian jail in Banja Luka. I've read about Auschwitz and other concentration camps, but this is the worst! There were nine of us in one cell. We were malnourished and drained mentally and physically. A man couldn't last three months. In a week more I would have succumbed. We were beaten with baseball bats every day. We were

forced to spend most of the day standing by our beds with our hands behind our backs.

"For walks and showers we had to run down three flights of stairs with our heads down and our hands behind our backs. We never knew when we'd get a knee or foot in the stomach. We marched in twos. A guard would say, 'OK, you on the left, get on the back of the guy on the right and hop around the square a couple of times.' Once I had to crawl 200 yards on my belly as if I was under fire.

"One night the guards came in 30 minutes before 'lights out' at 2200. They knocked the Muslim in front of me down and kicked him and stomped on him for a good five minutes. Then they said to me, 'HVO, kneel down.' They got behind me. One grabbed the upper bed frame and swung out to kick me from behind while the other guy was kicking me in front. I had internal bleeding. They left, then returned with a Louisville Slugger which they used on the Muslim. They said 'HVO, get ready, you're next in line.' I thought, *If he beats me with that bat, I'm dead.* The Muslim came back and crawled into his cell. Then a guard

said, 'HVO, come here.' I walked over to him, and he said, 'This kind of treatment is for cattle, not for men. Go there and sit down.' I guess it was the 'Man Upstairs' that saved me.

"It was right down to the wire. In Manjaca the Red Cross allowed us to contact next of kin.

"I was charged with war crimes, none of them true. They initiated proceedings, and I got a Serb lawyer. I was accused of atrocities, but they were disproved.

"The main prosecutor asked for an extension to look for more witnesses. I had already been before the judge twice and

thought I wouldn't make it through another extension. One day they came for me — I thought to go to solitary confinement — but they took me to sign papers. Since they could not find any credible witnesses to their false charges, the chief military prosecutor finally dismissed them, and I was released.

**SOF:** *What is your attitude toward your captors and Serbs in general?*

"In a sense, I feel sorry for them — I'll tell you why. They've been deceived by their intelligentsia and by their politicians for decades with atrocity stories that Croats supposedly committed during World War II. They believe the most ludicrous things. That's why they have such a hatred ... Their intelligentsia have been instrumental in destroying their own people. That's ironic, but that's the case."

**SOF:** *Did the Croatian and Muslim prisoners get along?*

"Yes, there was no falling out at all. We were all in the same shit. I feel sorry for them too, because the guys calling the shots now are hard-core fundamentalists. But the local Muslims, I feel sorry for them. These guys, when they occasionally got

packages from home, shared their food with me."

Ransom money is a pivotal part of POW releases by the Serbians: no ransom — no release. More often prisoners are simply killed, especially Muslims.

Sentences less than six years can be paid off with a ransom of DM 1,000 per year.

Davor Glasnovic had good reason to feel his time was running out. Time after time he was told he would be released shortly, only to be informed later that the Serbs had found "new evidence." This harassment was repeated many times. With his situation deteriorating rapidly, Davor felt that in a few more days he would be killed.

While Davor Glasnovic was in captivity, his mother, Neda, returned to Croatia and courageously tried to make contact. Serbian authorities toyed with her grief through threats of reprisals for his alleged atrocities, many times making false accusations and setting trial dates. Various individuals and agencies intervened on Davor's behalf, but the fact his twin brother is commander of one of the most effective Croatian brigades did not weigh in his favor.

As the ransom demands escalated, Neda went to extreme ends to raise more. An anguished mother's love is without limits and Neda, with the help of Davor's aunt — both elderly, retired women — and a cousin, raised the demanded ransom of \$20,000 Canadian.

The funds were in cash: DM 20,000, plus \$5,000 Canadian. Arrangements were made for delivery by a courier from the Canadian consulate. As the Canadians would not be party to ransom, the Serbs said the money was for "attorney's fees."

With the exchange completed, the Canadian Embassy in Belgrade released the ransom money to Davor's Serbian lawyer. Word has it the money was split between the prosecutor, the judges and Davor's attorney.

Following a period of recovery in a Zagreb hospital, Davor Glasnovic was medevaced home to Canada, where he now faces corrective surgery and rehabilitation.

*A frequent traveler to the Balkans, correspondent Robin Anthony has contributed a number of stories to SOF on various facets of that conflict. ✕*



A "recovered" Davor Glasnovic convalesces in Zagreb hospital before being medevaced to Canada after his 15 months of hell. Photo: N. Antonini/Novosti

In a front office/apartment crammed with computer terminals, photocopiers, fax machines, telephones and filing cabinets, two portraits — one of Thomas Jefferson, the other a copy of Gilbert Stuart's famous rendition of George Washington — watch over 38-year-old Kirk Lyons and his dedicated staff at the modest headquarters of the CAUSE Foundation.

This unlikely venue has become an information clearinghouse — a veritable nerve center — for civil lawsuits filed on behalf of families involved in the tragic standoff near Waco, Texas. At no cost to its clients, the non-profit CAUSE Foundation is helping people shunned by such supposedly benevolent — and much better-financed — liberal organizations as the Southern Poverty Law Center (SPLC) and the American Civil Liberties Union (ACLU).

In the mind of a conservative, Lyons' credentials might set off alarm bells. He is a card-carrying member of the ACLU; he is a lawyer. If that's not bad enough, he's a lawyer who's been compared to William Kunstler, the left-wing radical attorney who typically defends like-minded extremists and revolutionaries, including Black Panthers, cop killers and other violence-advocating militants.

It was Morris Dees, a civil rights attorney heading the SPLC, who compared Lyons to Kunstler.

"I would take that as a very high compliment," Lyons told *Soldier Of Fortune*. "I think the kind of cases I'm involved in are where the First Amendment is being tested now. In the '50s, it was the Communist Party. In the '60s, it was the radical student movement. In the '70s, it was with the Black Panther party and the Black Muslims. In the '80s, it was skinheads — in the '90s, it's people like David Koresh."

Some critics call Lyons "an advocate for bigotry," referring to CAUSE's defense on vital constitutional grounds of people affiliated with the Ku Klux Klan and other unsavory organizations.

Dees claims CAUSE is a nationwide fund-raising organization for white supremacist aims, a charge Lyons vigorously denies: "Left-wing critics will point out that Kirk Lyons has been to a Klan rally. Yes, I have attended a Klan rally. I've been right there watching the cross light up — as an observer.

"It is just the same as if I went to visit a synagogue on a

Saturday. That doesn't make me a Jew. But when I go, I'm not going to spit on the floor and piss in the corner. I am going to act respectful, as a guest should, and the same thing if I am invited to a Klan rally.

"I am a member of the ACLU and, of course, a lot of these right-wingers don't like that," Lyons added. "The ACLU does a lot of good work on the First Amendment. Anybody who supports the First Amendment ... needs to be a member of the ACLU."

When he called Dees in an attempt to get the SPLC to take the cases of some Branch Davidians, "they were rather surprised to hear from me," Lyons recalled. "They said they talked to Mr. Dees, and Waco is just not the kind of case that they handle ... They asked me if [the Davidian church members] were white supremacists. I told them it was more like the Rainbow Coalition in there."

Lyons and David Hollaway, head of legal research for CAUSE, went to Waco during the siege in hopes of defusing what they immediately perceived as an extremely dangerous situation. They petitioned a federal judge and beseeched the FBI to let them arrange for independent negotiators.

"It was our position that independent negotiators would bring a speedy and peaceful resolution to that situation," Hollaway said. "In every federal standoff since Wounded Knee [South Dakota, 1873], those which have used outside, neutral negotiators ended in a peaceful solution. Those that have not and in which the government retained control have ended in injury and death — mostly by fire."

Their bid was rejected, but Lyons and Hollaway organized the Lawyer's Response Committee in Waco, which played the key role in securing famed Houston defense attorneys Dick DeGuerin and Jack Zimmermann to represent Davidian leader David Koresh and his lieutenant, Steve Schneider, respectively. The committee also obtained highly skilled legal counsel for other Davidians who, unlike Koresh and Schneider, survived the fire.

CAUSE is representing some of the Davidians and their surviving families, but only in civil lawsuits against the government. Federal tort claims from the Waco siege totaling more than \$100 million have been filed thus far by CAUSE attorneys. The foundation has also sued several federal agents and the Waco Police Department for the illegal

arrest of Louis Ray Beam, a former Texas KKK leader who was in Waco covering the standoff for *Jubilee* magazine.

Beam was ejected from a press conference for asking a question that riled the feds; Waco police jailed him as a result. CAUSE sued, arguing Beam's constitutional rights to free speech and press freedom were violated.

# JUST CAUSE

## Lawyers Band Together To Fight For Conservative And Constitutional Issues

by James L. Pate



CAUSE Foundation's directors: from left, Dr. Neill Payne, David Hollaway and Executive Director Kirk Lyons. CAUSE stepped into the Waco case to defend constitutional issues for clients deemed unworthy by more liberal organizations. Photo: James L. Pate

Continued on page 82

*In 1976 the Rhodesian SAS formulated an audacious plan to send 200 crack troops to attack some 6,000 trained and armed ZANLA (Zimbabwe African National Liberation Army) terrorists at their training base/sanctuary near Chimoio, deep inside neighboring Mozambique. With air assets and logistics spread painfully thin, the troops jumped from C-47 ParaDaks or were landed from Alouette III choppers to form a box around the entire compound. At the conclusion of Part I, A Troop commander Captain Robert MacKenzie had just jumped into the maelstrom and the ground assault on the terrorist camp was beginning.*

# ***FAST STRIKE*** **ON CHIMOIO II** **Mopping Up Mugabe's Minions**

**Text & Photos by Robert MacKenzie**

**Once on the ground,** I freed myself from my lines and checked my men to ascertain that there were no casualties from the jump. Changing to the command net on my other radio, I reported to Major Brian Robinson, overhead in the C&C helicopter, and learned that a coordinated movement of the sides of the box was about to start.

The 25 men in my stick closed to 10-meter intervals in thick bush and mopani forest, forming a sweep line some 250 meters in length. The other half of A Troop, under command of Capt. Colin Willis, was in a similar formation on my left flank, with B Troop's 48 men on line at least a kilometer off to my right. On command from Robinson, the SAS sticks started advancing toward the camp, while the RLI (Rhodesian Light Infantry) troopers held their positions and shot any terrorists fleeing the sweep lines.

As the SAS closed in on the center of Chimoio, they drew fire from ZANLA riflemen, either singly or in small groups, and occasionally one would leap up and try to sprint through the gap between troopers. In every case the result was the same. Using a tracer-heavy mix in their belts and magazines, whenever an SAS soldier spotted a target, he would immediately engage it. The men on either side of him, put onto the target by tracers fired by the first trooper, would add rounds of their own and the target would be destroyed almost instantly. As every fourth trooper on the sweep line was carrying an RPD light machine gun, a heavy volume of fire could be, and was, delivered even

while moving, and the sweeps continued to inexorably close on the terrorists' perimeter.

About 150 meters from the enemy trenches, the command net crackled and I heard that the C&C helicopter had been hit and had to retire. Robinson said he would be back soon and ordered all units to hold their present positions until then. Attempts were made to get a chopper in to pick up the alternate commander, but he was engaged in a firefight far from an LZ and was too busy being a rifleman to take command. The sweeps came to a halt, in some cases within visual range of their first objectives. K-cars and Lynxes continued attacking from the air where they were drawing enormous amounts of antiaircraft fire, but the ground war tapered off to sporadic bursts as Mugabe's finest tried to escape through the closing Rhodesian lines.

## **Tightening The Noose**

For more than an hour, officers and men waited in the heat, fuming at the delay, knowing the enemy must be slipping away through the inevitable gaps in their lines and through the side of the box that was supposed to be closed by K-cars. The gunships were much diminished in their number now, due to refueling and rearming requirements. Lying behind trees in the forest, some of my troops were enjoying themselves as they watched guerrillas sneaking toward them: Hope would grow on the enemy's face as he thought he was escaping, only to be shot a few steps from safety.

I continued to monitor the command radio, following the airstrikes through pilots' chatter, listening as K-cars and jets worked in tandem to subdue enemy gun positions and as they rotated back to Rhodesia or to the admin base 15 kilometers away. With the all-important element of surprise having been used up, there was a growing apprehension that some of the enemy commanders could be organizing their forces for a concerted attempt at breaking out of the box, or worse, a counterattack.

Even a concentrated group of 30 or so guerrillas would have little trouble in smashing through the one-man-thick Rhodesian line. Clearly, the enemy had scant idea how few troops were attacking them, and the constant presence of the air force was both deadly and demoralizing, but the men in the sweep lines were feeling more vulnerable with every passing minute.

Finally, at about 0930, Robinson once again was in orbit — higher this time — and the box started closing again. As

forest and a long zigzag trench line. As our machine gunners sent burst after burst onto the lip of the trench, the riflemen threw grenades and then charged. Leaping in along a wide front, they found only a few enemy, mostly cowering at the bottom. Chimoio's perimeter was now breached, with several hundred meters of it occupied by the Rhodesian army.

### Into The Valley Of Death

Calling in my RPD gunners, I ordered a brief break to reorganize and reload. Forming our own defensive position, I reported to Robinson and received permission to send out patrols to deal with pockets of guerrillas who were still fighting, and to capture secondary objectives that had been assigned during the planning of Op Dingo.

Leading a 15-man patrol back into the forest toward our next objective, the ZANLA intelligence center, my point element signaled there were enemy ahead. The patrol deployed on line and advanced cautiously toward a large clearing. In the middle of the clearing stood a 30-foot tower with a DShK 12.7mm anti-aircraft machine gun, its crew frantically blasting away at every plane in sight.

Preoccupied with aerial targets, neither the four gunners nor their security party on the ground saw the SAS patrol creeping to the edge of the clearing. Silhouetted against the hazy sky themselves, the crew were perfect targets. On command, my troopers opened fire. Bodies tumbled off the tower onto the group guarding the base of the tower, who were also shot before they could return fire. Still on line, my patrol swept across the clearing into the woods on the other side where we found another AA position. Unoccupied, this one had a Chinese twin-barreled 37mm cannon, still in cosmoline. Happily for the air force, it had not been put into action: A few pounds of plastic explosives soon ensured that it never would be.

### Mugabe's Nerve Center

Sweeping through another 150 meters of woods, during which 15 to 20 more terrorists were flushed and killed, my patrol reached ZANLA's intelligence center. It comprised 18 grass huts which served as offices, classrooms and storerooms, and, although surrounded by more trenches, had been

abandoned. The compound was checked for defenders as the patrol moved through, then secured and searched in detail. My men brought piles of notebooks, diaries, files, and bushels of other ZANLA documents from the huts for a quick sorting by another of my officers and I before being backloaded to Rhodesia. There, they would get more intensive study by military and police intelligence experts.

While the officers were engaged in the drudgery of paper sorting, an excited shout from Corporal Bates Mare



my stick neared the enemy perimeter we heard heavy firing break out on our left, punctuated by repeated, vicious cracks from a recoilless rifle. Knowing that Willis and his men must be seriously engaged and might need help, I alerted a couple of K-cars and then called Willis for a report. He didn't need help though, as he and some of his troops had executed a quick flanking attack on the terrorist gun emplacement and killed all eight occupants. In less than 10 minutes his line was reformed and moving again. Off to the right, a rapidly rising crescendo of small-arms fire and explosions indicated that B Troop was having similar problems, confirmed by a request for casevac from the troop commander: The SAS had taken their first casualties on Op Dingo, with one trooper killed and another two wounded.

Another 100 meters brought A Troop to the edge of the

**Overrun and torched, Mugabe's premier terrorist training base at Chimoio burns to the ground on first day of attack by Rhodesian Special Air Service, light infantry and air force.**

alerted the rest of the troops that he had found a darkroom and hut full of cameras — dozens of them. Aware as always of booby-trap possibilities, Mare and another NCO moved cautiously into the hut, and then came out with enough gear to equip a busload of Japanese tourists. Thousands of dollars' worth of new Leica, Pentax and Nikon 35mms, and a couple of rare video cameras — intended for ZANLA intelligence agents — were now in the possession of a bunch of happy troopers. Nearly an hour later, satisfied that the paper sorting was complete, the patrol set fire to the compound and moved back to its defensive position.

By about 1230 virtually all enemy resistance in Chimoio had been broken, and a systematic search and destruction of the base began as groups of SAS and RLI troops fanned out through the complex. Some of my men called me to an open-air classroom under the forest canopy. It had taken a stick of bombs from a Canberra straight through the middle, giving at least 60 former students their final lesson in terrorism. Blackboards blown over by the blast carried drawings of AK-47 rifles and terrain sketches, and the students' notebooks were filled with the wisdom of Chairman Mao. Many of those notebooks were red, like Mao's little red book ... but for a different reason. Airstrikes had clearly taken a heavy toll throughout Chimoio, and together with those killed by rifle fire, some 600 dead guerrillas were counted in the headquarters area alone. Later intercepts of ZANLA radio traffic indicated that more than 1,200 terrorists had been killed in the battle, and 100 more were missing. (ZANLA's final count was over 2,000 dead.)

### Collecting The Spoils

Poking around a shattered hut in what had been an administrative center for Chimoio's domestic affairs, I was looking for more documents when I found a new Samsonite briefcase. I was just about to unlock it with my bayonet when Robinson ordered me to take a patrol over to a motor pool about a kilometer away, so I tossed the briefcase onto a heap of papers gathered for later sorting and backloading. I alerted a sergeant to bring a demolition kit and seven more troops, and we set off. As we walked across the expansive, open field that formed the center of the Chimoio complex, our demolition party could see thick billows of smoke and flames all around as the heart was burned out of Mugabe's main base. Sadly, Mugabe himself was not in residence at the time of the attack. Explosions, large and small, gave more evidence of supplies and arms being destroyed, and we could hear brief, scattered firefights as the huge camp's occupants continued to be flushed from their hiding places and shot.

When we reached ZANLA's motor pool, our demolition team was surprised to find three buses, six cars — including a big, new BMW — several pickups and a few large trucks. A well-equipped repair shop, gasoline and diesel tanks, and an office in an old farm building suggested a much higher degree of organization than we had previously encountered — but also promised an undoubtedly impressive explosion once we had completed our work.

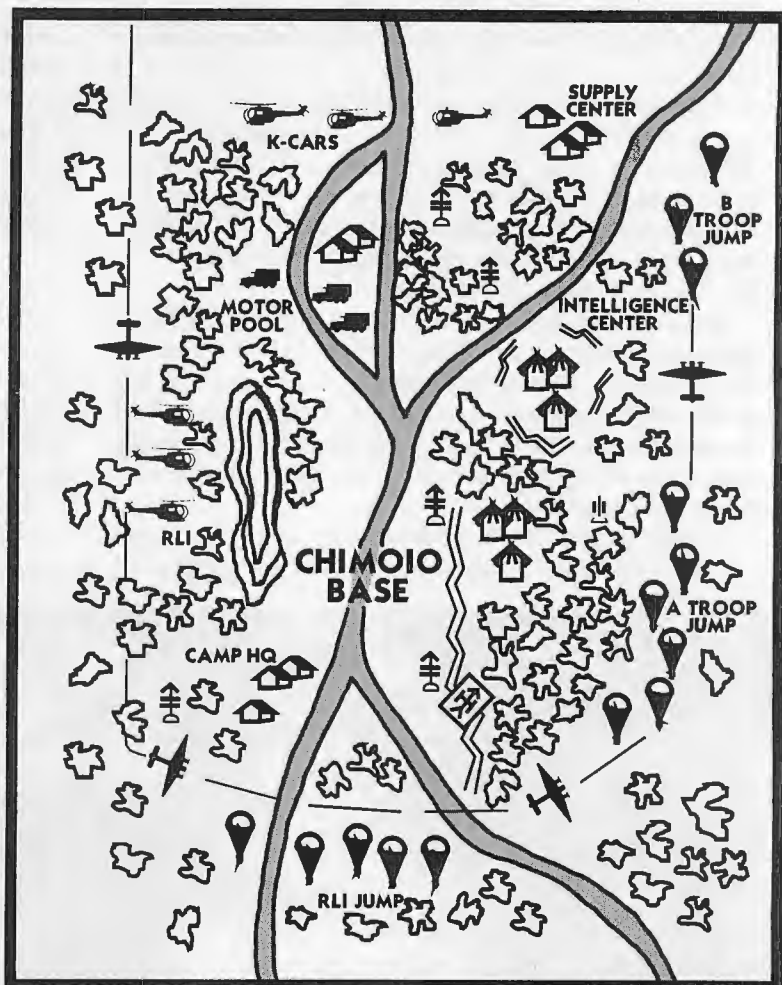

The terr camp at Chimoio was boxed from the south and west by Rhodesian Light Infantry and from the east by A and B troops of the SAS; K-cars closed the top of the box as Rhodesian forces inexorably closed and overran the camp. Map: Sibly Cline/Krissie Anderson

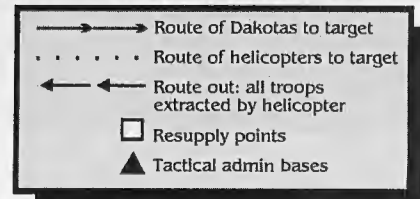
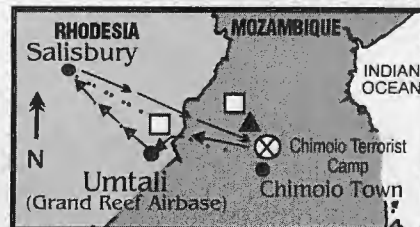

Some 20 minutes later, charges had been placed on everything of value — except one pickup truck — and connected into a long det-cord ringmain. Advising all aircraft of the impending bang, I sent everyone but a machine gunner away on the pickup, then lit the fuse. The gunner and I walked a few hundred meters away, took cover where we could prevent any interference with the charges, and awaited the blast. Five minutes later the whole lot went up in a gratifying fireball and mushroom cloud.

After the heavy shower of vehicle parts had abated, the truck came back and our now-mechanized SAS patrol set off to tour Chimoio via the base's antiaircraft positions. Since the Rhodesian army was short on heavy machine guns, every one that could be recovered was certain to be of use in future operations, and 13 DShK 12.7s were eventually bouncing in the back of the vehicle. Collecting them

was not without incident, however.

Ever aware of the possibility of "friendly" fire, I was careful to announce to all stations on the operational command net that we were travelling around in a captured pickup truck before we started off. About halfway along, I was alarmed to hear two Hawker Hunter pilots talking on the net about a group of terrors escaping in a white truck; they were about to turn in and "fire them up."

From the pilots' radio call signs, I realized that they were recent arrivals and clearly had not been briefed about our movement. I was anxiously shouting "Stop, Stop, Stop!" into the handset and getting ready to abandon our truck, when a powerful transmission broke into the net, ordering the Hunters not to attack. The new voice belonged to General G.P. Walls, ComOps commander, who was monitoring the battle from a specially equipped command C-47 Dakota orbiting inside Rhodesian airspace. I felt a strong surge of relief, then another of warmth and respect for the general, who obviously was paying attention to the details of the battle into which he had sent his men.

By the time our commandeered vehicle was full of captured 12.7s and had returned to A Troop's position, helicopters had already started moving men and matériel back to the relative safety of the admin base. From there, South African helos conducted a longer shuttle back to Rhodesia. According to the plan, all troops were to be out of Chimoio before dark, but as the afternoon progressed it soon became apparent that not everyone would get out as scheduled. Half of A Troop was chosen to stay until morning, so, just before dark, the 25 men moved off to a different set of trenches and settled into a defensive posture for the night.

From the shelter of my CP in a centrally located bomb crater, I reviewed the day's events with my command group. As always in a battle, each participant only sees a small part of it, and it is always interesting and useful to compare experiences and perceptions. During a whispered conversa-



**Commandeering a truck, author (on radio, trying to get Rhodesian aircraft to cancel air strike on his vehicle and men) sets out to tour (glean) Chimoio for documents and plunderable ordnance.**

tion carried out over rapidly diminishing tins of bully beef, Color Sergeant Koos Loots wondered if anyone had found the thousands of dollars that were rumored to be somewhere in Chimoio.

I flashed back to the Samsonite briefcase I had found earlier, and as casually as possible asked my second-in-



**Chinese Type 63 twin 37mm AA gun (copy of Soviet M1939) was captured at Chimoio still in ordnance grease. Too big to take to Rhodesia, it was blown in place (inset).**

command what had become of it. "It's still where you left it, sir. We didn't get a chance to send back that pile of stuff yet." I drifted off to a sleep dreaming of a suitcase full of money, often interrupted by gunfire from all around Chimoio as surviving guerrillas battled each other, or shadows. I would find that case first thing in the morning.

### **... And Keeps On Ticking**

Only once during the night did a small group of wanderers stumble into the SAS perimeter. In a brief firefight three more terrorists were added to the tally of kills. After a full day's fighting, the adrenaline-sapped Rhodesians, partly restored by tea, bully beef and dog biscuits (hard army crackers) and wrapped in captured blankets, were glad to get what sleep they could.

With first light came a message from Rhodesia that as soon as the pilots had breakfast, helicopters would leave to pull out the last of A Troop; a pair of Hunters was already en route to cover the withdrawal. Arrival time for the choppers was given as 45 minutes. I quickly organized a small patrol to get the last of yesterday's captured documents, and soon had the still-locked briefcase in hand. Declaring, "Chaps, we're about to be rich," I popped the first latch with my bayonet. When the second latch gave way to the same treatment, I paused for a second, then lifted the lid. "Bugger! Nothing but bloody papers," I said, shaking the case disgustedly. With the shake, though, a new Rolex watch bounced out and into my hand. "Keep it. You earned it, sir," commented a corporal — who had acquired a new camera the day before. Only a low-end Rolex, it nevertheless brought more than a month's pay when I sold it in Salisbury a few weeks later.

Back at our LZ, I asked the Hunter pilots for news of the

*Continued on page 71*



# RUN SILENT, RUN DEEP

## Fast-Attack Submarines Patrol Poseidon's Perimeter

by Dale B. Cooper



### *"Officer Of The Deck – Man Battle Stations!"*

When this alert sounded over the onboard PA system, 15 officers and 120 enlisted men stopped whatever they were doing to run for duty stations on the double.

Before the USS *Key West*'s Officer Of the Deck (OOD) even finished speaking, I heard off-duty radiomen, torpedomen, fire-control technicians, sonar operators and quartermasters rolling out of their racks one deck below me. The terse battle-stations order is a moment of truth for any U.S. Navy crew on a fast-attack *Los Angeles*-class SSN (Ship, Submersible, Nuclear-powered).

As onboard sonar made contact with an unknown surface ship, I was in the attack center talking with Commander Bob Kuppers Jr., skipper of the *Key West* (SSN 722).

The 39-year-old Naval Academy graduate turned to his executive officer, Lieutenant Commander Lester Moore, to receive information. At the tactical display-console panel, four operators plugged in their headsets.

Kuppers, who has spent the past 18 years in six submarines, four of them fast-attack types, barked a series of commands, bringing the sub to its highest alert. The air turned electric as others of the control room crew came running past the officers' staterooms. These navigators, talkers and plotters headed for the attack center. It had taken less than two minutes for 25 men to respond to the OOD's call.

The killer sub swung into action. "All ahead two-thirds – 250 feet, manning battle stations. Attention all quartermasters, clear the deck and the con," the OOD snapped.

"Sierra Four One," the contact being tracked, was acquired at 14,000 yards' distance shortly before 2400. The target vessel's personnel were unaware of their pursuers beneath the moonlit Atlantic waves near TOTO (Tongue Of The Ocean – an area off the coast of Andros, the Bahamas' largest island), where the *Key West* had just completed its annual Tactical Readiness Evaluation (TRE).

A deep trough of ocean about 20 miles wide, TOTO extends some 100 miles in length at a depth of 6,100 feet. As when it "fought" a surface vessel for 72 hours under every conceivable TRE combat scenario, the *Key West* rose to periscope



USS *Key West* running full-bore while surfaced. Speed is essential for fast-attack subs; depending on an enemy's angle of attack, this SSN can outrun a torpedo. Photo: U.S. Navy



depth to close in for the kill.

"Sierra Four One is a trawler, bearing 310," Moore observed as his controllers set up a firing solution. The simulated attack certainly sounded real to me. Although there are 20 to 25 men in the attack center during a fire mission, the sound level is extremely low. Koppers never raised his voice as he explained what was happening.

"As the noise level increases, so does confusion, and things begin to fall apart," the skipper remarked. "Quietness is something you live with out here, so we work hard to maintain it. Hopefully, the more tense it gets, the quieter it gets in here."

A noticeable hush fell over the attack center while Koppers hung a series of confidential cards around his neck, the so-called "tac aids" that serve as a last-minute checklist. "There's an awful lot of things that have to be happening in the heat of battle. The cards keep us from overlooking those things," he said.

Sitting next to the CO's tactical display-console operator was the controller who generated fire-control solutions. The guy beside him operated the firing panel controlling torpedo tubes. A fourth fire-controller sat at the weapons panel. Quartermasters plotted the course manually in case onboard computers "crapped out."

Each man around me monitored a separate screen with a different algorithm, trying to resolve the target's course, speed and range. "Once we know that, we simply tell the weapon, and the weapon's own logic knows how to find out where it has to go to detect the target with its own sensor, home in and destroy it," the captain explained.

It didn't take the *Key West* long to close on its target — just a couple of

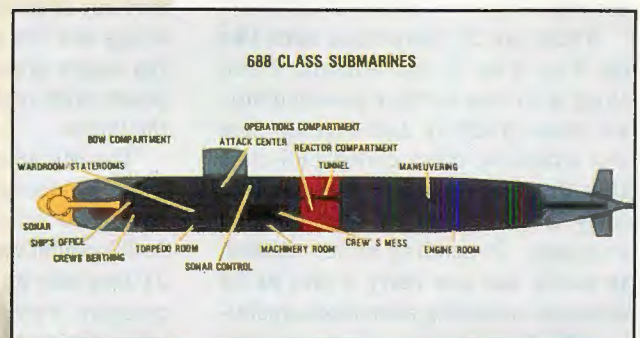

Layout of *Los Angeles*-class nuclear fast-attack SSN; sophisticated sonar array can simultaneously track multiple enemy submarines.

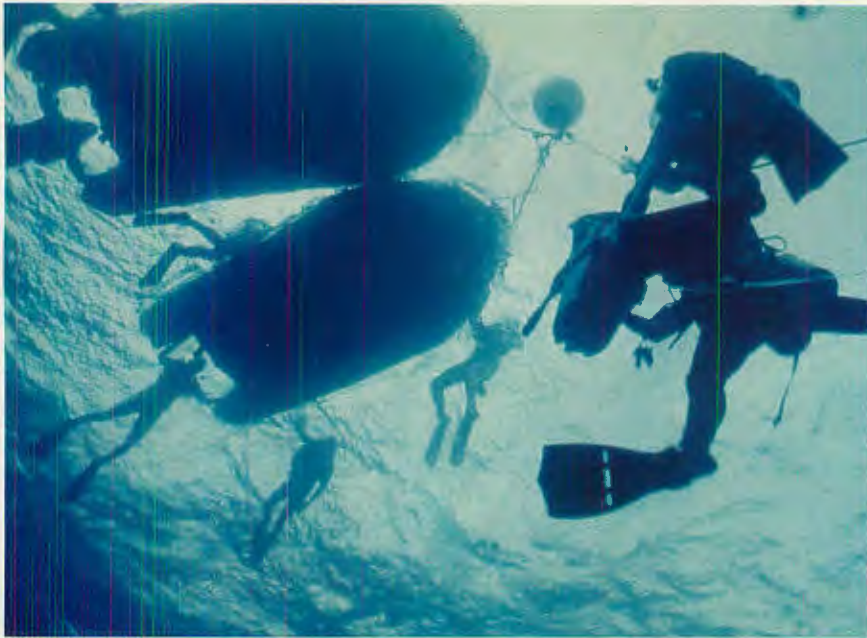

SEALs ascend from sub to surface craft; the Pentagon is currently concentrating on elite-force covert ops and ending the nuclear Navy's easy access to the federal treasury. Photo: U.S. Navy

minutes. The trawler's captain didn't have a clue that his ship was in the sub's cross hairs. "Shoot on generated solution," Koppers ordered. This command was relayed to the torpedo room.

An officer shouted, "Fire Tube One!" *Clunk* — we felt the sub shudder. When I later sat at the torpedo firing panel and launched a water "slug," the sound was deafening.

*Whoosh* — a rush of high-pressure air was followed by a ringing noise as some 2,000 pounds of pressure shoved a ram of water down the tube. Up to 20 torpedomen service weapons during an actual shoot. Like every other area on board, their work space is cramped. If they lose hydraulics and have to manhandle torpedoes into the tubes, torpedomen can work up a sweat like their World War II predecessors.

There are 55 fast-attack subs like the *Key West* in the Atlantic Fleet, along with nine nuclear-powered missile boats (SSBNs). *Los Angeles*-class fast attackers, often called 688-class after the *Los Angeles*' hull number, carry a vast array of sophisticated weaponry. Depending on its mission, an attack sub can carry a mix of 37 weapons, including advanced-capability Mk 48 torpedoes, Harpoon anti-surface-ship missiles and Tomahawk Land Attack Missiles (TLAMs). The TLAMs are launched from 12 vertical tubes mounted in the sub's bow, while

other weapons are launched amidships from four 21-inch-diameter torpedo tubes.

Ship-launched TLAMs demonstrated accuracy and effectiveness during the Gulf War; 288 of the 18-foot-long missiles were launched in the Red Sea and Persian Gulf. The Tomahawk is an all-weather weapon, pursuing the contour of enemy terrain at 550 mph. From submarines, a TLAM is ejected by high-pressure air; once clear of the sea, its small wings and fins extend while its turbofan engine ignites to propel the 1,000-pound high explosive warhead toward the target.

The Mk 48 torpedo has a sophisticated guidance system permitting a variety of attack options. When the 3,450-pound weapon is thrust from its 21-foot tube by 2,000 pounds of high-pressure water and air, a thin wire spins outward from its rear. This wire enables an operator (with access to the sub's extensive sonar system) to initially guide the torpedo toward a target. The copper wire, mounted on a

spool looking like the nylon-cord fixture on a garden "weed-eater," also helps the torpedo avoid any enemy decoys or jamming devices.

Eventually this wire is severed; the torpedo's high-powered active/passive sonar guides it through the final phase of attack. Mk 48s carry 650 pounds of high explosives — enough to send a surface ship to the bottom if properly placed.

The *Key West* fired five weapons during its TRE. A naval evaluator praised Lieutenant Junior Grade Marc Lucas' 20-man torpedo team as the best unit out of 27 sub crews recently tested. "Top TORP [torpedo] is better than Top Gun!" Lucas laughed. But jokes can't mask the inherent dangers of underwater service.

Every time they submerge, submariners recite a prayer that their boat will resurface. Yet only twice in the



On ocean floor 400 miles southwest of the Azores in mid-Atlantic, the USS *Scorpion*'s sail rests at 10,000-foot depth. Only recently has U.S. Navy announced 1968 sinking was probably triggered by sub's own flawed torpedo. Photo: Woods Hole Oceanographic Institute

history of the nuclear Navy has a U.S. submarine been lost at sea.

### Silent Service Nightmare

In 1963, the USS *Thresher* sank on routine maneuvers off the New England coast. Its crew of 129 lie some 8,500 feet down. The *Thresher* carried no nuclear weapons.

Another SSN, the USS *Scorpion*, went down with a loss of 99 men about 400 miles southwest of the Azores on 22 May 1968. After a quarter-century, the Navy has admitted for the first time that the sub was apparently sunk by one of its own conventional torpedoes. A recently declassified Navy report indicated a torpedo somehow be-

came armed, so the *Scorpion's* crew jettisoned it. Shortly thereafter, the torpedo's rudder must have malfunctioned. The weapon turned around and headed straight at the vessel.

The renegade torpedo apparently struck the sub's sail, or fair-water bridge. The explosion set up an enormous underwater shock wave, hurling crew members against bulkheads. The *Scorpion* plunged 10,000 feet like a rock and smashed into the ocean bottom in less than two minutes, gouging a pair of 30-foot-deep trenches. Water pressure crumpled the sub's hull like a beer can.

Not until 1986 was this explanation of the sub's self-destruction advanced. Deep-sea submersible craft from Massachusetts' Woods Hole Oceanographic Institute photographed the *Scorpion's* wreckage scattered over 600 yards of ocean floor. Their photos and a subsequent official investigation were kept secret until this past 26 October.

The *Scorpion* was found split into two major portions. Its forward hull section, including the torpedo room and most of the operations compartment, lies in one of the two trenches. In the other lies the aft, or rear hull section, including the reactor and engine rooms. The aft hit bottom with such force that its engine room jammed into a larger-diameter hull section like a closed-up telescope tube.

Analysts discount foul play; when disaster struck, no Soviet or Eastern Bloc warships were within 1,000 miles of the *Scorpion's* last-reported position. Along with conventional torpedoes, the sub's arsenal included two nuclear-tipped Mk 45 ASTOR (Anti-Submarine Torpedo Ordnance Rocket) torpedoes — "low-yield tactical weapons," according to Pentagon sources.

Environmental groups voice great concern that similar weapons aboard sunken Soviet subs threaten the Black

Sea with 600 years' pollution. Monitoring data from the Woods Hole scientists, however, confirm no significant impact on radioactivity in the environment at either the *Thresher* or *Scorpion* accident sites.

Nuclear fuel remains intact in both hulks; surveys undertaken at the *Scorpion* site detected no plutonium exceeding levels resulting from fallout of past atmospheric weapons testing. U.S. subs' reactor cores are engineered

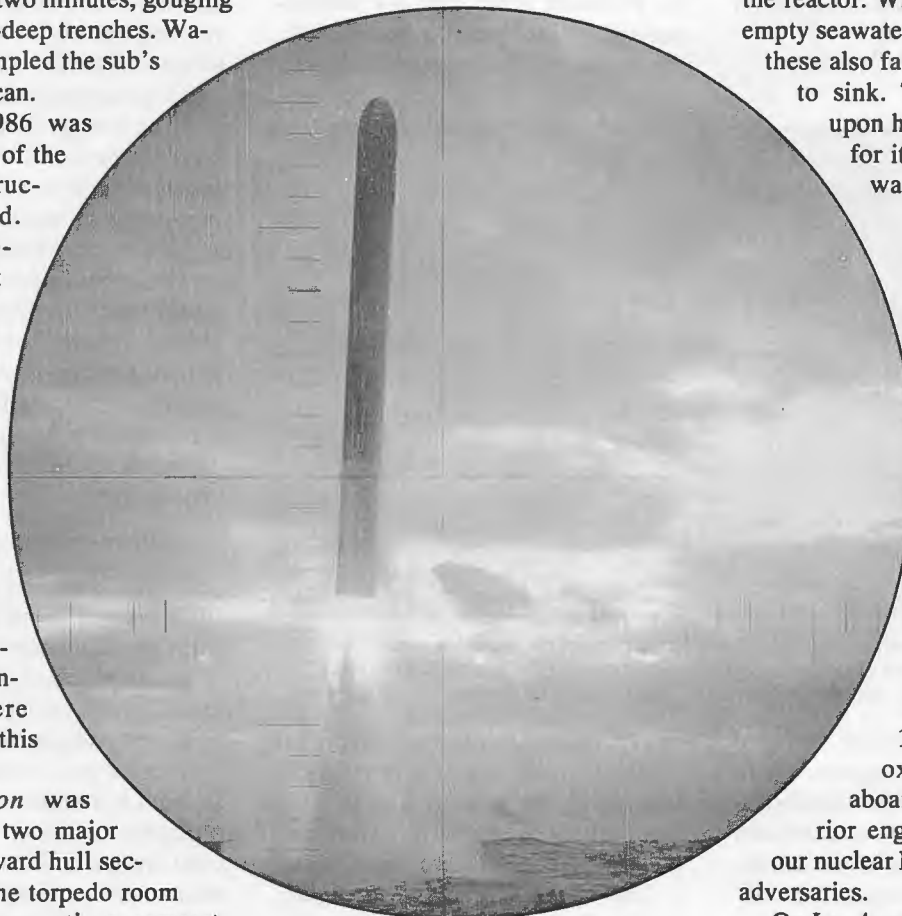

18-foot-long Tomahawk missile launched from USS *Pittsburgh* nuclear attack sub during Gulf War. *Los Angeles*-class SSNs can fire Tomahawks from 12 vertical tubes mounted in bow. Photo: U.S. Navy

to make a bomb-type explosion physically impossible, unlike poorly designed Russian reactors.

Even if a U.S. sub sinks, its reactor core could remain submerged for decades without releasing fission products, since the protective cladding on those fuel elements corrodes only a few millionths of an inch per year. That's according to the Atomic Energy Commission's Division of Naval Reactors.

The secret of why the *Thresher* sank

still lies with her crew under the Atlantic, but the declassified report agrees with long-held suspicions that a punctured pipe was the likely culprit. A quarter-inch hole in a submarine pipe 400 feet below the ocean's surface would allow a gush of water to shoot into the vessel as if discharged from a fire hose.

It's believed flooding on the *Thresher* shorted electrical circuits, triggering an automatic shutdown of the reactor. When the captain tried to empty seawater from the ballast tanks, these also failed, causing the vessel to sink. The sub was crushed upon hitting a depth too great for its hull to withstand the water pressure.

The *Thresher* went to sea with faulty silver-brazed pipe joints, even though joint failures on other subs had caused the Navy to order an inspection as early as eight months before. Extensive measures were subsequently taken to reduce operational casualties in submarines. The Atlantic Fleet has sustained just three casualties since 1963, all to electrolytic oxygen-generator plants aboard missile boats. Superior engineering clearly gives our nuclear Navy the edge over any adversaries.

On *Los Angeles*-class subs, surface targets can be identified easily through one of two camouflaged periscopes. Periscope No. 1 features optics-only World War II technology, including the characteristic thin head that creates only a small wake on the sea surface. For this reason, No. 1 is known as the "attack periscope."

Chock-full of cameras and antennas, the No. 2 scope can sample much of the surrounding radio and electromagnetic environment while providing a visual search of a target. Someone always mans this scope, whether an officer or enlisted watch-stander, even when diving or surfacing.

Submariners observe their world through a periscope's 32-degree window. In order to visually cover the entire range (360 degrees), one must

walk the scope around in circles. Continuous periscope sweeps enable crews to monitor civilian and military surface vessels, or to distinguish airborne threats.

With good visibility, surface targets can be detected out to 20,000 yards, allowing plenty of time for evasive maneuvers. "The last thing we want to do is surface under another ship, like a French sub did last year, or break water next to a pleasure craft and scare the dickens out of people on board," Kuppens said.

Near its home port of Norfolk, Vir-

ginia, the *Key West* once surfaced alongside a sailboat regatta. "You should have seen those sailboats skedaddle," recalled one seaman who had been on watch amid the confusion. However, visual target ID is only one option for an SSN crew.

Submariners don't have the luxury of visually identifying underwater vessels. Instead of optics, they rely on aural clues. Different boats make different sounds. To the untrained eye, lines on sonar display screens look like a lot of electronic clutter; to a trained eye, they provide clues as to the identity of a potential target.

Likewise, different-class subs emit varying identifiable sounds. Sonar operators worth their salt can distinguish a Soviet-made *Delta III*-class or *Typhoon*-class boat carrying ballistic missiles from sounds of a Russian attack-fleet sub. Sonar technicians are submariner virtuosos, a crew's eyes and ears. Without them the sub is blind and deaf to underwater threats.

Being assigned to a "floating box"

area of responsibility also helps U.S. submarine crews keep tabs on who's playing in their wading pool. Two SSNs or SSBNs are never assigned to the same box formation or geographic grid coordinates, thus if sonar gets a contact on a submerged target, chances are it's a stranger. At this point, the "pucker factor" really increases.

Improved *Los Angeles*-class subs like the *Key West* have 2-inch-thick rolled HY80-steel pressure hulls able to withstand more than 44 pounds-per-square-inch per 100 feet of depth. These vessels are designed to contract

ter to control the sub's depth and angle. The duo may be ordered to "thread the needle" — failure to give their captain the precise angle he calls for could determine if an incoming weapon will be evaded.

The helmsman and planesman are at the controls whenever the *Key West* goes to battle stations. They are like Siamese twins, or Sulu and Chekov of *Star Trek* fame. Yet it's not uncommon to see a junior officer like 25-year-old Lieutenant Steve Rich running the ship while the captain sleeps, or to find 24-year-old Shawn Lewis occupying the helmsman's seat.

"The strange thing is, I don't even have a driver's license," Lewis laughed, "and here I am driving a billion-dollar submarine."

I even got a chance to drive the sub — yes, it has power steering, but one must avoid "overdrive." The steering column is sensitive to touch; you've got to ease up when approaching a desired angle on the bow, or else you'll wallow like a whale. But such navigating skills are demanded of only a chosen few.

### Submariner Drawbacks

It takes a special breed of sailor to fit in and master the particular hardships borne by submariners. The pay is good: an extra \$150 to \$350 per month for enlisted personnel. Promotions are also decent, but submariner volunteers pay a heavy price. Family separation and lack of privacy, in this order, are two major duty complaints cited by *Key West* crew members, some of whom have young children.

Submariners live in a virtual news blackout — no ball scores, either. The crew rarely gets a newspaper; if they do, it's usually several days' or weeks' old. The sub's mess has a VCR and plenty of microwave popcorn, but after awhile, you've seen all 300 movies on board, including *The Hunt For Red October*.

Jim Atwood, master chief in charge of the *Key West*'s radio room, explained that when his world starts closing in at 50 fathoms down (300 feet), he crawls into his rack — an area just over 72 inches long, 24 inches wide and 18 inches high — to commune with his family, whose pictures are taped to surrounding pipes and ventilation ducts.

For someone used to sprawling out in a king-size bed, sleeping on board



Loaded with cameras and antennas, SSN's No. 2 periscope provides visual search while sampling radio and electromagnetic environment. This scope is always manned for continuous 360-degree sweeps. Photo: Dale B. Cooper

or expand as they dive or surface, but no sub is made to take a torpedo hit. Puncturing the pressure hull is fatal; that's why subs like the *Key West* continually practice evasive maneuvers.

Fast-attack subs move so rapidly that a sailor could probably water-ski behind one if surfaced, but Kuppens assured me no such gear was aboard. When asked how fast and how deep an attack sub can submerge, Cmdr. Dave Morris, my escort officer and SUBLANT (Submarine Force, Atlantic Fleet) spokesman, replied: "Faster than 20 knots and deeper than 400 feet." However, a quick search in an easily accessed naval reference source indicated a "dive" top speed of "30+" knots, coupled with a maximum diving depth of 1,475 feet for a *Los Angeles*-class SSN.

Speed is essential for killer subs. The *Key West* could outrun an enemy torpedo (depending on the angle of its attack), but there's no margin of error for the helmsman and planesman. This pair sit side by side in the attack cen-

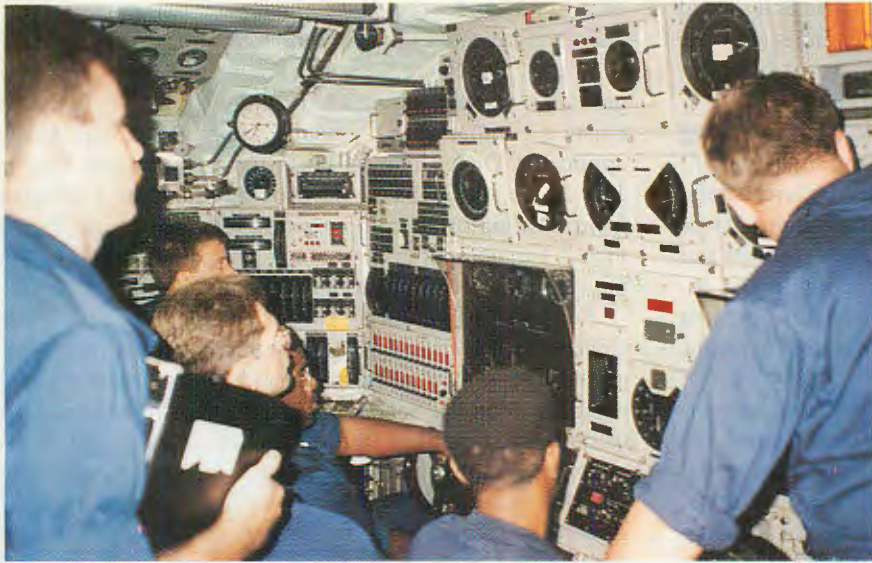

As *Key West* submerges, submariners monitor dive-panel array in attack center. This improved *Los Angeles*-class SSN's pressure hull contracts and expands for diving or surfacing. Hull's 2-inch-thick high grade steel can withstand more than 44 psi per 100 feet of depth. Photo: Dale B. Cooper

the *Key West* was like resting in a casket at the local funeral parlor. The only thing missing was a bouquet of plastic flowers.

Communications with loved ones are limited. There are no telephone booths nor mailboxes onboard; the only way for submariners' kin to communicate is via "family-grams." Each crew member's family can send up to eight of these 50-word-maximum messages during a regular 90- to 120-day deployment. Family-grams consist mostly of "how are you," "I am fine," and "we miss you," but wives and girlfriends sometimes communicate more personal sentiments through use of codes.

Before seeking any "Silent Service" duty, potential submariners should consider whether they could accept the job's protracted cycles of isolation, its cramped habitat, and its hushed atmosphere.

Quietness is next to godliness in a submarine. During World War II, sub captains about to be depth-charged by Japanese destroyers would pass the order to "rig for silent running" — a command never given today. When a nuclear vessel submerges, it's assumed the crew will reach a level of silence.

Black anechoic tiles covering their outer hulls give subs a prehistoric look, but they also absorb interior and exterior sounds. Still, technology can only silence so much noise; the rest is up to the crew.

Kuppers likes diving his sub at 25-degree angles to "turn and burn" as a

fighter pilot would. Everything onboard is supposed to be stowed — in other words, nailed down. "We 'angle and dangle' for two reasons," Kuppers explained. "One is to see what's loose and clanging around. The other reason is to practice evasive maneuvers. You play the way you practice." Become careless and you could get killed. The captain has been known to blow his cool when things clang around during high-speed maneuvers.

After the trawler shoot, the entire crew stood down from battle stations. Those whose sleep had been interrupted trudged back down to their berthing areas. Other seamen returned to the mess deck for pizza. Pizza means a cruise is about to end; it's always served the night before this sub hits a port.

Sometimes it seems like all a crew does is eat aboard a nuclear submarine. Meals are served every six hours when watch shifts change, but once an SSN submerges it can seem like one long day. "In fact, it really doesn't matter whether it's day or night," observed Lloyd Holbrook, a machinist's mate. One can keep track of time by checking what chow is being served: If it's eggs, it's got to be between 0500-0600. Of course, cooks must watch the clock since they dish out the meals.

Chief Petty Officer Steve Cantillon feeds 120 enlisted men in the crew's mess, 24 at a time. Fifteen officers eat on the other side of the galley in the

ward room. During a regular deployment, enough provisions are put aboard to feed the crew for 90 to 120 days. Space is at a premium, so cans of Diet Coke syrup get stuffed under seats in the crew mess; containers of food are stacked on the deck and covered with rubber mats. A crew literally eats its way topside.

### Roll Over Rickover

As "father of the nuclear Navy," Admiral Hyman Rickover once told Congress, "I don't believe in cost-effectiveness when buying submarines." For more than four decades, a compliant Capitol Hill agreed — but times have changed.

For the first time since the end of World War II, America's defense budget, passed by Congress and signed by the president last year, contained no money for new submarines. But construction does continue on a backlog of attack and missile subs contracted for during the Reagan-era defense buildup.

Four key developments brought the nuclear Navy to today's phase of no growth — the Soviet Union's collapse, skyrocketing construction costs, strategic arms-limitation agreements and political pressures to cut defense spending. Pentagon planners are even considering what would have been heresy under Rickover: returning to diesel-powered subs as a cost-cutting measure.

"Ironic, isn't it?" mused Vice Admiral George Emery, SUBLANT commander. "We're returning to what we did 50 years ago when we ferried Marine Raiders to faraway islands in the South Pacific on diesel boats."

One thing bugs Emery about America's planned decommissioning of numerous attack subs and missile boats by the end of this decade: "The Russians are still building nuclear subs. There's got to be a reason." Yet intelligence experts say only a handful of Russia's subs are now at sea. Still, its engineers are hard at work designing a new generation. Such points take on added significance when mulled over in an SSN's close quarters.

Time had come for a fresh breath of real air, away from the atmosphere below decks. But few crew members could go topside; there's little room on the bridge.

*Continued on page 68*

**An army is designed**, equipped and trained to wage war. Our American Army has demonstrated its ability to perform this task superbly whenever it has been well-led and allowed to accomplish its mission.

The profession of soldiering is a noble but demanding one: A soldier deploys wherever ordered and fights whom-ever he is told to fight, no questions asked. Unfortunately, although the national interest or policy that sends our troops abroad to fight may likewise be noble, our government and military establishment are not equally honorable and increasingly rely on semantics and doublespeak to present things in a politically correct light — which generally means different than they truly are.

While researching the benefits and entitlements that veterans of Somalia *should* be receiving as they face armed militias on the streets and in the countryside, we discovered some repugnant examples of such semantic manipulations.

For instance, troops deployed to Somalia do not receive “combat pay,” at least under this term. Today, such a pay entitlement is called “imminent danger” or “hostile fire” pay — “combat pay” is simply not politically correct. The evolution of this artful terminology springs from the fact that since the Vietnam war, the government has had difficulty in getting popular support for sending troops to a “combat” zone: Such contrived jargon facilitates end-runs around both Congress and the American people.

fails to fall under the War Powers Act, which the military claims is necessary for a combat zone to be declared by Congress. The Pentagon states that this tax benefit must be granted by Congress, which must declare war before there exists a combat zone to which such a benefit is legally applicable. Once again, this is mil-speak at its best. Section 112 of the U.S. Tax Code provides for “the exemption from taxation of all compensation received for active service ... for any month during any part of which [the] member served in a combat zone.”

Further, the *Standard Federal Tax Report* published by Commerce Clearing House states that “a member of the armed forces who performs service in an area not designated as a combat zone, which service is in direct support of military operations in a combat zone and is performed under conditions that qualify the member for hostile fire pay, is deemed to have served in such a combat zone.” According to this, he is entitled to the combat pay exclusion for that period of service.

The apparent message here? If you served in Somalia, go right ahead and file for this combat tax exemption next April. The worst thing that could happen is the IRS refusing to accept it. If you file correctly and have your documents and references in order, it should be a tax exemption to which soldiers are rightfully entitled.

The most obnoxious word game is the “declared war”

# PENTAGON WORDGAMES

## REMFs Decide Who Gets Combat Honors

by John Zimmerman and Greg Walker

A married serviceman deployed to Somalia loses his rations allowance, but will draw family separation pay and foreign duty pay. In the balance between gaining “hostile fire pay” and losing one’s rations allowance, our troops are lucky to break even for the questionable privilege of being shot at.

### Strangling On Semantics

Another example of the game-playing in Somalia is the lack of a combat-zone tax break afforded those serving in Somalia, as opposed to those who served during the popular Gulf War. Even in the latter years of the war in El Salvador, such a tax benefit was authorized by Milgroup commander Mark Hamilton, and military personnel took advantage of the program. But because troops fighting in Somalia are fighting while on a “humanitarian peacekeeping” mission, no tax break.

As an officially humanitarian deployment, the operation

charade. The only war declared formally by Congress since World War II was the promptly concluded ride through Kuwait and Iraq’s deserts, a war which cannot be compared to the horrors of World War II, Korea, Vietnam, and myriad other miserable little Third World wars in between. We note that the combat zones of Korea, Laos, Vietnam, and El Salvador were never declared such by Congress — yet most if not all wartime benefits and entitlements were granted, conflict by conflict: A president can declare a theater where military actions are taking place as being a “combat zone,” and enlisted men and warrant officers can claim the appropriate tax exemption.

The political niceties of mil-speak can also affect what is reflected in the individual serviceman’s 201 (personnel) file. Despite the reality of ground combat for troops serving in Somalia prior to 5 June 1993, their 201 files will not reflect a combat tour. Conversations with a senior Pentagon spokesperson on this issue introduced us to the term

“force protection” as opposed to “offensive combat.”

The Pentagon is more than happy to blame their claimed inability to properly acknowledge a combat tour prior to the 5 June date as being, somehow, the fault of Congress. For not declaring war? Congress hasn't declared war in Somalia since 5 June, but the Pentagon is now authorizing combat awards and decorations because the troops are now known — thanks to the free press — to be up to their cargo pockets in spent shell casings and “offensive” operations.

According to self-acknowledged CIB expert Sergeant First Class O'Keefe, of the Army's Awards and Decorations Branch, it was a change in the mission that now allows for post-5 June troops in Somalia to be acknowledged as having combat tours, as opposed to pre-5 June troops whose records will indicate they went to Somalia for solely humanitarian purposes.

### Make Words Not War

O'Keefe told *SOF*, “Prior to June 5th, the troops' mission was not to go out and seek the enemy. They were only to provide protection to those attempting to deliver food, and to provide support for other troops who came under fire, like in an ambush.” And what is the mission after 5 June? O'Keefe stated, “After the ambush of the 26 Pakistani peacekeepers our forces were authorized to mount offensive combat operations to provide protection for those attempting to deliver food and to provide security for other forces coming under fire.”

Sounds like the same mission to us — give or take a couple-dozen dead “peacekeepers.”

Nor are U.S. personnel, like other U.N. troops, receiving direct pay entitlements from the United Nations for their services. The joint chiefs of staff rejected a request from U.S. Central Command and U.S. European Command (for those American troops deployed to Macedonia) to allow our troops to draw U.N. pay supplements. This pay equals

A collector's dream ... a “peacekeeper's” nightmare: U.S. Marines raid the Bakara arms market in Mogadishu, finding everything from modern heavy weapons to this M1928 Thompson. In a punch-up with a force that is thus armed, organized and shooting, it sure *seems* like “combat.” *Combat Camera* photo by PH1 Oriez USN, courtesy DoD



\$1.28 per day for U.N. service, and \$10.50 per day as a recreation allowance. This is paid for every day after six months of service. The U.S. Foreign Assistance Act does not allow direct U.N. payments to our troops.

The brogue of mil-speak grew even thicker during a conversation with a representative of the DoD from the compensation policy director's office. We asked why other armies serving under the U.N. flag receive such pay and ours don't:

“Our government pays its soldiers what it can by law and we pay them adequately,” we were told. “This [U.N. pay] is primarily for Third World countries ... to get them to participate.” From this are we to conclude the secretary of defense considers Canada to be a Third World country? Canadian troops draw the U.N. entitlement “to participate,” even though their servicemen are paid more on average than their U.S. counterparts.

Grant Willis, an *Army Times* staff writer, recently quoted an unidentified Pentagon pay specialist as saying, “If we need to pay them, we'll pay them [the U.N. allowance] as it is a piddly amount ... We have a pretty good pay system. We should really educate our troops about that.”

Somalia is only a repeat of the non-acknowledgement of combat efforts by U.S. military personnel, as typified by the case of those who served in El Salvador. According to the Salvadoran military attache's office in Washington D.C., “No recognition of U.S. advisers is now currently under



Marines sweep Bakara arms market in Mogadishu on Operation Nutcracker. This cache — enough weapons to fill a Deuce-and-a-Half — will not become spoils of war. Why? Because there's no war here — just ask the desk jockeys at the Pentagon. *Combat Camera* photo by PHCM Terry Mitchell USN, courtesy DoD

consideration.” Privately, a senior Salvadoran officer at the embassy offered that intense pressure had been put upon the Salvadoran high command by the Pentagon *not* to make such an award available. Again, the denial of a combat role by U.S. troops in El Salvador appears the primary goal of mil-speakers at the Pentagon, with the troops who fought, bled and died there left holding an empty bag.

Americans participating in and supporting the U.N. operation in Somalia prior to 5 May 1993 have yet to receive

*Continued on page 68*



# WACO WHITEWASH CONTINUES



Commercial video footage shows western end of Mount Carmel gymnasium, at left, still standing about 1155 Central Standard Time on 19 April. Photos: CBS News, courtesy California Organization for Public Safety



By 1159, gym walls and roof are completely collapsed. Simultaneous FBI infrared aerial photo shows heat plumes — possibly an outbreak of fire — rising almost immediately after collapse. Justice Department report confirms people were inside gym.

**Like beauty, truth is** in the eye of the beholder. So behold a report submitted to Attorney General Janet Reno, the second of two Clinton administration investigations into the Waco disaster. After evaluating its own performance, the Department of Justice (DOJ) concludes there is “no place ... for blame” on FBI agents or

other decision-makers, according to Edward S. G. Dennis Jr., who was in charge of the probe.

The DOJ report is “an objective evaluation ... an independent assessment,” Deputy Attorney General Philip B. Heymann assured reporters when it was released on 8 October 1993. (For a Who’s Who in the DOJ, see sidebar.)

# Feds Find No Fault With Their Handling of Branch Davidian Standoff

by James L. Pate

Unlike the Department of Treasury's soul-searching tome on Waco, which details a litany of lies, blunders and lame cover-up attempts by Bureau of Alcohol, Tobacco and Firearms (ATF) agents, the Justice Department's report exonerates its personnel who took over the case after the monumental failure of the ATF raid.

Indeed, Dennis stressed to reporters that he had "tried to be as objective ... in the judgments I have made ... I've tried to stay relatively detached and unemotional ..." He then went on to condemn David Koresh, the megalomaniacal, messianic leader of the Branch Davidian religious commune, deploring "the spectacle of children's lives bartered like pieces of silver by a twisted mind ..."

Dennis said he could "find no fault in the performance of law enforcement during the standoff and the tear-gas assault," of this past 19 April which, literally or not, sparked a raging fire that ended the 51-day siege — and the lives of almost 90 people, about half of them women and small children. "Although in hindsight there were some mistakes made, I don't believe they were gross errors in judgment ..."

Mistakes? Definitely. Gross errors in judgment? You bet. No matter which side of the argument one comes down on, Reno must live with the fact that the fire most likely would not have started if FBI negotiators had kept talking that day. As with President Kennedy's assassination, the Waco tragedy — how the fire started, what the FBI should or should not have done — will be endlessly debated for decades to come.

Provided, of course, that Uncle Sam's badge boys don't summarily suspend the First Amendment.

The report's conclusion on the cause of the fire — that a small group of loyal followers set three separate fires on Koresh's order, thus fulfill-



Photo: James L. Pate

ing his prophecy of doom — is anchored to the findings of a supposedly independent arson-investigation team.

Critics charge that the objectivity of the arson investigation effort was tainted by selection of the team's leader, Paul Gray, who is married to an ATF employee and who worked out of ATF's Houston office for eight years ... the same office that was in charge of the Waco raid. The Grays were close friends of Steven Willis, the first of four ATF agents slain in the 28 February 1993 Waco raid; both attended Willis' funeral.

Flames were still raging in Waco when a DOJ spokesman in Washington blamed the fire on the Davidians. That claim was based on the reported account of an FBI sniper who, after looking inside Koresh's home through a rifle scope, said he saw a male figure dressed in a black Ninja-type outfit and black hood pouring what appeared to be a liquid on the floor behind a piano, then lighting it.

Neither the spokesman nor the report commented on why a Branch Davidian might have been dressed like an FBI agent, or why a person about to commit suicide would give a hoot in hell if he was identified.

*"I'm always concerned about the perception of a whitewash ... I go out to seek the truth, and that's what I've tried to do here, and I'm going to do everything I possibly can to seek the truth." — Attorney General Janet Reno, commenting on the U.S. Department of Justice's report on the Branch Davidian standoff near Waco, Texas.*

Despite its endorsement of Gray's findings, the DOJ report contains information — buried in footnotes and obscure passages — that raises new questions about how the fire started. And one revelation indicates that the FBI, like the ATF just prior to its raid, deviated from an approved plan. In both instances, the deviations were preludes to disaster. (ATF's blunders are detailed in "Government's Waco Whitewash," *SOF* Jan. '94)

The FBI's plan was to use specially rigged Combat Engineering Vehicles (CEVs) to punch holes in the Branch Davidian building. Then, the riot-control chemical CS could be sprayed inside to force occupants out. Referred to in the DOJ report as "an emergency assault plan," it was formulated "during the first week of the standoff ... for use by the FBI in case of homicide, or combined homicide-suicide ... It was generally agreed ... [that the plan would be executed] if an emergency response was warranted ..."

Acting Attorney General Stuart M. Gerson, a Bush administration hold-over who remained until Reno was sworn in on 12 March, "had determined, in line with the President's understanding of FBI policy, that the

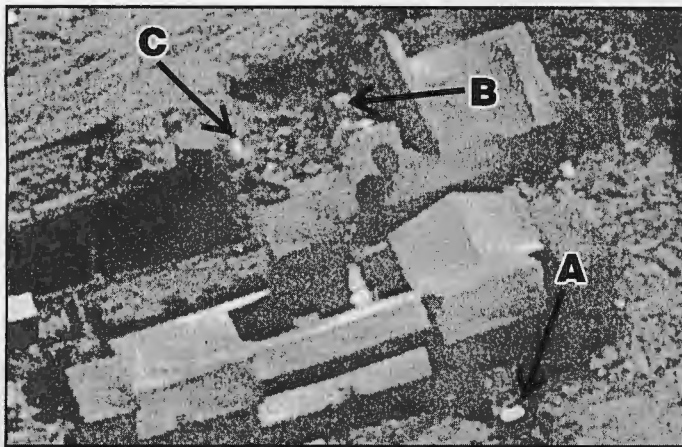

Still photo from FLIR video taken on 19 April by FBI at 11:59:19 a.m. Central Standard Time shows: (a) heat plume on exhaust port of CEV on south side of complex; (b) heat plume from CEV exhaust amid rubble of collapsed gymnasium, and (c) heat plume from unknown source — possibly fire when roof caved in — in gym rubble. Photos: courtesy California Organization for Public Safety



Still photo at 12:04:55 p.m. Central Standard Time from FBI's FLIR video shows: (a) heat plume on second floor at southeast corner of complex — FBI cites this as first point of ignition in fatal fire; (b) heat plumes spreading out through rubble of collapsed gym, possibly indicating early point of ignition.

FBI's strategy would be to 'talk them out, no matter how long it took,' " the DOJ report states.

This thinking apparently changed after Reno took office, when it was decided that "an indefinite siege was not a realistic option ... The decision to insert CS gas was a reasonable one," approved with the proviso that the final operation would escalate *gradually* over a 48-hour period.

But three hours after the final assault kicked off around 0600 on 19 April, "an apparent deviation from the approved plan began," Dennis reveals near the end of a separate, 63-page addendum to the 500-plus-page DOJ report. "The plan [was] that the building would only be dismantled if after 48 hours not all the people had come out."

The DOJ report mentions several times the claim that FBI agents never fired a shot during the 51-day siege. But a careful viewing of videotape shot during the six hours between the start of operation and the fatal fire reveals another type of violence by FBI agents: a significantly elevated level of aggression by the CEVs against the Branch Davidian structure.

This is where the issue of how the fire started gets ticklish. The alleged arson, Dennis wrote in his addendum, was "the result of David Koresh's determined efforts to choreograph his own death and the deaths of his followers in a confrontation with federal authorities to fulfill Koresh's

apocalyptic prophesy."

The DOJ report attempts to cloud the importance of how the fire started by claiming that "probably the most important observation that can be made about the Waco standoff is that ... nothing would have changed the outcome because the people who remained inside had no intention of leaving."

But details buried in the four-volume report suggest many Branch Davidians may not have been able to escape the flames because they were trapped — due to the increasingly violent ramming of the wood-framed structure by CEVs. The report confirms that:

- Falling debris — whether from the fire or CEV demolition is unknown — blocked a trap door leading to an underground shelter where FBI agents said they hoped to find survivors. The report states FBI Hostage Rescue Team members entered the underground chamber from the outside as the fire still raged. Inside, the air was clear and cool, the report notes, but no one was found.

- A front stairway leading to women's and children's quarters on the structure's second floor collapsed after a CEV smashed through a wall near the double front doors, possibly trapping people upstairs.

- The roof over the gymnasium/auditorium area collapsed after a load-bearing wall was knocked down by a CEV trying to penetrate to the building's center. Although not stated

in the report, it is likely that instead of providing an additional avenue of escape, the roof's collapse trapped and possibly killed people in that section of the structure. The report does list the bodies found in that vicinity — people who, the government says, died from blunt trauma and smoke inhalation, not burns and gunshots.

- Citing Gray's arson investigation, the DOJ report concludes that Davidians set three fires within two minutes: (1) at the southeast corner of the compound's second floor, at 12:07:41 p.m. Central Standard Time; (2) in a dining area in the middle of the ground floor, at 12:08:49 p.m., and (3) on the east side of the first floor, in the chapel area, at 12:09:45 p.m. But still photographs taken from the FBI's aerial infrared videotape and included in the report's appendices show an apparently spreading heat plume, possibly indicating a fire that started a few moments before noon, when the gym roof collapsed.

Ranch Apocalypse fire theories by critics of the government range from accidental ignition to deliberate murder. The presence of numerous gasoline and kerosene lanterns in the vicinity of hay bales piled against interior walls smashed by the CEVs makes accidental ignition plausible — a potentially ruinous scenario for the FBI in a civil suit alleging wrongful death.

Indeed, Dennis concedes in his addendum the federal arson investigation could "not rule out the possibility that the spread of the fire could

have been enhanced by spillage of flammables caused by the FBI breaching activities," but he continues to insist it was set by Branch Davidians.

*Soldier Of Fortune* is aware of no evidence that the fire was deliberately set by government agents, a viewpoint argued by worst-case conspiracists. The most far-fetched — and completely unsubstantiated — rumor from this camp cites gunshot wounds in many victims to allege that a foreign hit team was secretly inserted into the building, then the fire was set to hide murders.

Linda Thompson, an Indianapolis lawyer who produced a VHS-format videotape titled *Waco: The Big Lie*, is best-known of those who contend our government set the fire. The most riveting footage in her video, produced with commercial-network images, shows a CEV backing out of a gaping hole in the building while what appears to be flames spew from its CS spray tube. "According to Ms. Thompson, that scene establishes that the FBI used the CEV to start the fire ... deliberately," the DOJ report states. "We have investigated Ms. Thompson's claims and find them baseless ... CEV-1 [the vehicle seen in the Thompson video] was not in that location when the [12:07:41] fire started ..." (But timed video indicates the presence of another CEV at the southeast corner of the building when

the 12:07:41 fire is first seen.)

The report details a split-screen video analysis of the incident, one portion taken from the conventional footage contained in the VHS cassette Thompson is selling and another shot from a circling FBI aircraft equipped with a Forward Looking Infrared Radar (FLIR) video camera. That analysis concluded that "the infrared tape shows a heat source — the exhaust — at the rear of CEV-1, but no heat at source at the front," where Thompson's video shows what appear to be flames.

Two analyses of the Thompson video — one by *SOF* and another by the California Organization for Public Safety (COPS) — indicate the DOJ's conclusion about Thompson's video is correct.

The *SOF* analysis, conducted by military officers qualified in either armor or the use of riot-control agents, indicates that: (1) The CEV shown is not configured with a flame-emitting capability, and (2) the liquid form of CS emitted by the CEV was non-combustible.

However, the results of the COPS analysis promise to be much more problematic for the DOJ than the Thompson video. The good news for Reno is that it proves the CS spray tube in the Thompson film is not spewing fire. The bad news is that the COPS analysis raises much more serious

questions, and does so using the government's own evidence.

These questions include: (1) Were there four points of ignition instead of three? (2) Was the first fire actually ignited when the gym roof was collapsed by a CEV plunging toward the middle of the building? (3) Were people trapped by the collapsing roof, some dying of blunt trauma while others were pinned in the wreckage as a raging fire swept toward them?

There is contemporaneous evidence to support these postulations. Attributing it to FBI agent Jeffrey Jamar, overall site commander in Waco, *Newsweek* reported in its 3 May 1993 issue that "altogether, there appeared to be as many as four separate blazes." Renos Avraam, a fire survivor, told his lawyer that "a tank ran into the corner of the building and it basically collapsed. Then someone shouted, 'A fire has started!' The black smoke was intense."

The painstaking work by COPS included a review of "hundreds of hours of video material from numerous sources," said Mike McNulty, chairman of the group and an *SOF* reader. It involved a highly technical examination of the video itself. COPS obtained footage seen in the Thompson VHS video, but in its original Beta format, which has a much higher optical resolution. With the assistance of film experts in California, COPS had the images digitized, then the computer-enhanced images were compared in a split-screen format.

In addition, McNulty's group was able to obtain different footage of the same incident, but filmed from other angles. COPS also got edited outtakes not shown in the Thompson production. The conclusion: What appears to be flames in the Thompson video is actually a visual trick caused by bright sunlight and dark shadows. The apparent fire at the end of the CEV's gas induction tube is actually shredded gypsum wallboard and other construction debris knocked loose by the CS sprayer boom.

(This author has watched the Thompson video a dozen or more times and it looked like flames to me. Richard Scruggs, a special assistant to Reno who compiled and catalogued facts for the DOJ report, agreed when I asked him about this. But the video analysis by COPS is conclusive.)

The COPS analysis notes that "at

Branch Davidian complex viewed soon after disastrous ATF raid of 28 February 1993; top of photo is north. Visible are: (a) two pickup trucks and cattle trailers used in raid by ATF; (b) location where CEV in Thompson 19 April video withdraws, appearing to spew fire from its tube; (c) southeast corner where FBI claims first point of ignition occurred on second floor at 12:07:41 p.m., and (d) gym/auditorium roof crumpled by FBI tank moments before noon on 19 April, when infrared film revealed heat plume erupting. Photo: courtesy FBI

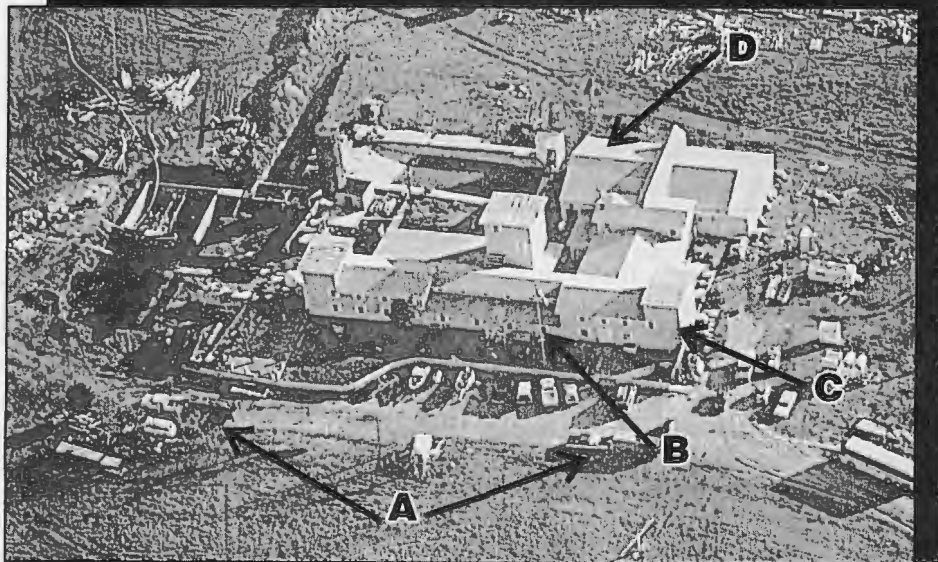

# ONE HAND WHITEWASHES THE OTHER

If you're lucky enough not to live in one of the crack-crazed, free-fire neighborhoods that have made our nation's capital notorious, life in Washington can be more like Hollywood than south Los Angeles. Those not high enough to actually enjoy the indulgent lifestyle that political power or stardom affords to many can at least repose in the golden glow of such largess; "gilt" by association, as it were.

Like Hollywood, much of what you see in Washington is illusion. It's similar to belonging to a many-tiered country club. The most-pampered people are known as "members." The importance of others is measured by which congressional "member" they work for. Then there are the tens of thousands of private jobs existing solely because of bureaucracy. Status and access are synonymous with "a need to know" — or "who you know."

Who you know is a key to long-term survival in Washington. It's also important to understanding what happens when the government says it is going to investigate itself — and that such a probe will be "independent." One must ask: Independent of whom or what? Independent of outside interference? It's hard to know who's who in the bureaucracy — where one hand whitewashes the other. Herewith is a Washington Who's Who of the Waco saga:

**Attorney General Janet Reno:** President Clinton owes her a heavy debt for acting as a political lightning rod on the Waco issue. Her performance won high praise. "Washington was at her feet," *Newsweek* magazine reported. "...Senators competed to praise her."

Despite that praise, the Department of Justice (DOJ) report makes clear that Reno misled us about the reason for ending the standoff, i.e., her claim of ongoing abuse of the Branch Davidian children after the 28 February 1993 gunfight. In an

obscure footnote of the DOJ report, we learn that after ordering up a comprehensive analysis of what was known about activity inside the besieged Ranch Apocalypse, the attorney general "did not read the prepared statement carefully, nor did she read the supporting documentation."

Thus has Reno become "a figure of low comedy," says *The Denver Post*, or "Miss Manners with an attitude." Post columnist Tony Snow called Reno "the architect of the Waco inferno."

**Assistant Attorney General Phil Heymann:** Heymann is a Harvard Law School professor who's been in and out of DOJ, but has stayed in touch with the pulse of power. His nickname — "The Plumber" — was earned as head of DOJ's Criminal Division under President Jimmy Carter. Heymann secretly checked newspaper phone bills in a quest to plug government leaks. Reno chose Heymann to "oh-so-gently investigate [Reno's] conduct," wrote syndicated columnist William Safire, "to put her fumbling in the kindest light."

To conduct the actual DOJ investigation of the Waco disaster, which began before Reno was sworn into office, it was in Heymann's (and Reno's) interest to "find a Republican-administration prosecutor — but a member of the Justice establishment [i.e., a club member] on whom [Heymann] had a hold," Safire noted. So Heymann picked ...

**Edward S. G. Dennis Jr.:** Like Heymann, Dennis is a former head of DOJ's Criminal Division. Dennis is also Heymann's longtime protege. It was as an assistant attorney general for the Bush administration that Dennis became a key inside figure in Iraggate. Dennis wrote a briefing paper for former Attorney General Dick Thornburgh on illegal loans to Iraq

made through an Italian bank's branch in Atlanta, Georgia. To offset a potential political embarrassment to President Bush, a "political fix" was imposed, Safire wrote, and Dennis' Criminal Division scuttled the state's prosecution in Georgia.

"To make certain no fingers were pointed at the Bush Justice Department's Criminal Division for an Iraggate cover-up during Dennis' independent investigation of Waco," Safire wrote, "Ms. Reno's Criminal Division directed [federal] prosecutors to shut down the explosive [Iraggate] case with a plea bargain, avoiding a public trial that would have exposed the machinations of the Bush-Thornburgh-Dennis crowd. How could Ed Dennis not be grateful?"

Waco is not the first law-enforcement disaster Dennis has investigated. As the U.S. attorney in Philadelphia, Dennis oversaw a probe of the Philadelphia Police Department — its unofficial slogan: "Death From Above." The Philly cops burned the homes of scores of innocent families in 1985 when it dropped a satchel charge on a row house occupied by a radical dirtbag group called MOVE. Like the Waco debacle, a refusal to come out led to their incineration, including women and children.

**Willie Williams:** Chief of the Los Angeles Police Department, Williams is a former Philadelphia police commissioner who was in the hot seat over the MOVE fiasco. Williams was one of three "independent" panelists chosen by Clinton to oversee drafting of the Department of the Treasury's report on the Waco disaster. If one was looking for two guys who might empathize with heavy-handed cops who had screwed up, the phone numbers of Willie Williams and Eddie Dennis would be a must.

— J. L. P.

approximately 11:59 a.m., the government's tanks caused the collapse of the gymnasium at the far northeast side of the complex, almost totally out of the media's view ... The media's attention was being drawn to the south side of the compound where tanks were still dismantling the southeast corner of the building.

"According to the government's

[infrared] aerial photo ... the gymnasium totally collapsed on the western half of the structure (roof and interior walls), and the roof was down on the floor with the exterior walls partially collapsed on the eastern side. The tank that caused the collapse appears to be in the midst of the rubble ... The most significant aspect of the government's photo is the time reference of 11:59:16

... [and] the obvious heat plume in the far northwest corner of the now-collapsed gymnasium rubble. In subsequent photos from the government's report, the heat plume can be seen ... spreading in the debris."

This would "seem to be at odds with the government account," McNulty told *SOF*. "The FBI claims that the first fire started at 12:07:41 at



**Looks like fire to me:** As seen in Linda Thompson's video, CEV withdraws from wall of Branch Davidian complex as what appears to be flames spew from its gas induction tube, between 1130 and 1140 Central Standard Time. Yet careful, computer-enhanced analysis indicates bright image is sunlight reflected from piece of gypsum wallboard. Camera was more than three miles away; visual distortion was magnified by atmospheric anomalies and distance, while optical resolution was degraded by use of VHS format videotape. Photo: CBS News



**Ed Dennis, overall head of the Justice Department's Waco investigation.** Dennis gave Reno, Heymann and the FBI a clean bill of health; in return, Reno ordered her minions to accept a plea-bargain in an Atlanta case that, had it gone to trial, could have been a political embarrassment for Dennis. Photo: James L. Pate

the southeast corner of the compound ... The evidence seems to support quite a different view on the subject of who may have started the fires, and when. By the government's own thesis, the Branch Davidians had to have started the fires because they were the only ones in the proximity when the blazes started.

"We can assume from the government report that the FBI tanks were at and in control of" the gymnasium area and the southeast corner of the building, McNulty said. "The government report has the FBI tanks at the southeast corner of the compound until 12:08:00 ... Therefore, the FBI was at least equally present and apparently in control of the first and second points of origin at the time of ignition."

As this issue of *SOF* goes to press, Parkland Memorial Hospital in Dallas announced its intention to sue the federal government for about \$370,000 in unpaid bills for treatment of three Branch Davidians burned in the 19 April fire. The DOJ responded in a letter to the hospital that it would not pay because the burn injuries received by the three Davidians were not the fault of the federal government.

Tom Cox, Parkland's director of

legal affairs, told *The Dallas Morning News* that the three victims, none of them having the means to pay, could just as quickly have been flown to the burn unit at Brooke Army Medical Center in San Antonio, where they could have been treated at government expense. The three Davidians were "certainly" in the custody of federal agents when they were brought to Parkland, Cox said.

Most interesting, though, is Cox's argument that the federal government should be held financially responsible for the bill because "federal authorities called the hospital the day of the assault on the cult compound, asking about the burn unit and available bed space," the Dallas newspaper reported.

Cox said the first call from the feds came that day about 0600, but he was unsure whether the burn unit was mentioned in that message or in a later call received that day.

Stay tuned.

*Editor's Note: Don't miss the March issue of SOF, in which James L. Pate finishes picking apart the DOJ report on Waco. Included are new revelations on: behind-the-scenes bickering within the Justice Department on how prosecutions*

*would be handled, and by whom; how the FBI managed to p.o. the ATF, the Texas Rangers and the Texas Highway Patrol; the constant turmoil on the Texas prairie between FBI negotiators and tactical teams; how the FBI ignored its own psychological experts and how the ATF — despite claims to the contrary — managed to stay involved in negotiations and investigations until almost the very end of the Waco siege.*

*A former SOF Associate Editor, James L. Pate is a freelance writer providing ongoing coverage of the Waco tragedy, its aftermath and the inherent ramifications affecting American citizens. ✕*

# DISPOSABLE



**The photo prominently** featured on this page first appeared in our October '93 issue. Its caption identified the ordnance being carried by this young resident of Kabul, Afghanistan, as a "modified/improved LAW" (Light Antitank Weapon). Well, it ain't necessarily so.

Through the sharp eyes of one of our readers in the intelligence community, we learned that this piece of ordnance is actually a Russian RPO-A (Russian shorthand for Rocket, Infantry, Flame thrower, model A). The name is slightly misleading as this weapon does not project flame in the manner a conventional flame thrower does. The RPO fires a projectile that produces a flame thrower-like effect on impact.

Consisting of three main parts — a container shell, ammunition assembly and engine — the RPO-A uses what is termed a Phase III Fuel-Air Explosive (FAE). Unlike those employed by Western forces, however, the RPO-A's 93mm FAE warhead cloud simultaneously deflagrates as it expands, thus increasing its potency over other conventional FAE weapons.

Though rarely encountered on Third World battlefields, the RPO has been around since the mid-'80s and has gone through several modifications. The original weapon was simply a launcher for a flame projectile; this was quickly modified into the RPO-A pictured in this article, a much more effective weapon.

As shown in a Russian sales video

Muj from Wahdat faction patrols Kabul neighborhood with Russian-manufactured RPO-A, single-shot flame thrower. Photo: Jake Border

obtained by *SOF*, the weapon was used in Afghanistan for blowing mujahideen out of caves and improvised bunkers. The Russians also tout the RPO as useful against conventional forces of various types as well as POL depots.

What makes the RPO-A round particularly deadly is that while its overpressure is substantially below that of conventional explosives, its duration is far longer due to the effect of its deflagration rather than detonation. This reaction is tremendously enhanced when ignited in an enclosed space, and the Russians liken the de-

# HEAT

## SOF Stumbles On Rarely Seen Russian One-Shot "Flame Thrower"

by SOF Staff



structive potential to that of a 122mm howitzer round.

The launchers are issued in "two-packs" and easily portaged with dual shoulder slings. They are disposable but also reloadable. There appear to be several types of RPO variants currently in existence/production.

One advanced variant was recently seen at an arms show in Turkey. The fact that this weapon is evolving shows that Russian research and development efforts continue despite the grim state of their economy. This latest version overcomes the problems of ear-

lier RPOs by combining a small, shaped-charge warhead as a precursor for the main FAE warhead. This allows the RPO to be fired directly at walls, bunkers or the hulls of light armored vehicles, rather than having to shoot through windows, firing apertures or other openings for full effectiveness.

The precursor warhead blows a hole for the main FAE charge to go through, and the subsequent fuel-air "explosion" is far more devastating when ignited inside rather than outside the target. This latest RPO model is reportedly highly effective against soft-skinned vehicles and bunker/pillbox-type emplacements, more so than any conventional infantry-portable warhead being manufactured,

according to our source. Applications for this weapon are limited only by one's imagination, and the Russians have even suggested civilian uses such as avalanche prevention and firefighting (extinguishing fires by explosion).

Little has been written about this weapon in the Western military press and its real world applicability and usefulness remain unproven. But from the looks of it, this is one mean mother you'd rather not find yourself on the business end of. ☒

### ROCKET INFANTRY FLAME THROWERS RPO-A



Designed to hit enemy concealed fire emplacements, to bring out of action light armoured and automove materiel as well as destroy enemy manpower. As a peaceful means the flame thrower can be used to lower snow-slips, to extinguish fire by explosion and etc.

#### SPECIFICATIONS

Calibre . . . . .	93 mm
Length . . . . .	940 mm
Range of fire, m:	
maximum . . . . .	1000
sighting . . . . .	600
point blank range at 3 m height target . . . . .	200
Initial velocity of the envelope . . . . .	(125±5) m/s
Mass of flame thrower . . . . .	11 kg
Mass of a pack of 2 flame throwers . . . . .	22 kg
Volume of destroyed or damaged objects with manpower at the inside explosion . . . . .	up to 80 m <sup>3</sup>
Enemy manpower destruction area on an open ground . . . . .	up to 50 m <sup>2</sup>
Temperature range of combat employment . . . . .	±50 °C
Warranted storage life . . . . .	10 years
Crew . . . . .	1 man

Mining effect of the thermo-vacuum shot is similar to blast action of a 122mm howitzer shell.

Disposable combat flame thrower. Empty containers are discarded after firing.



# COUNTERFEIT GUNS

that are inexpensive to own and safe to display in your home. They are realistic, full size working metal models that look, feel, weigh and handle like the expensive originals. You can work the action, release the clip and dry fire these high quality models.

**CANNOT BE FIRED!**

## ISRAELI UZI SUBMACHINE GUN

Used by Israeli troops in the historic 6-Day War, the Entebbe Raid. Adopted 30 other nations as the most successful sub-machine gun on the market today.

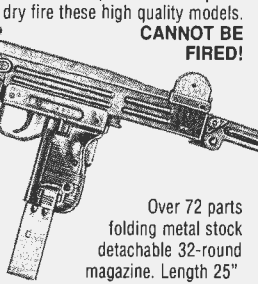

Over 72 parts folding metal stock detachable 32-round magazine. Length 25" Wt. 9 lbs.  
#01-705M.....\$310 PPD

**Exact Replicas in Metal!....**

## 1921 THOMPSON

as used by FBI & U.S. combat troops. Over 59 parts, including vertical foregrip, detachable wood buttstock & 20-rd. magazine. Lgth. 35". Wt. 9.5 lbs. Disassembles like original.

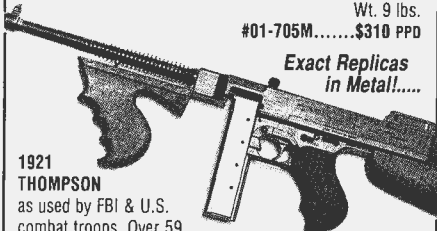

#01-700 .....\$299 PPD

**Full size (non-firing) models look, weigh, and handle like the originals.**

## M-16 ASSAULT RIFLE

The ultimate defense arm as used by S.W.A.T. forces. Made famous by U.S. troops in S.E. Asia. Full size. Bolt functions like original—over 70 ABS plastic and metal parts. CANNOT BE FIRED. Lgth. 39". Wt. 5 lbs.



Declared "non-gun" by the Federal Gov't.  
#39-2707.....\$300 PPD

**FULLY ASSEMBLED**

## U.S. 45 AUTOMATIC

A favorite of GI's for 80 yrs., from WWI to Vietnam. This metal "non-firing" replica model is exact in every detail—even the grip safety

works. Blued finish. Can be disassembled. L: 8.5" W: 2.5 lbs. #01-300  
\$107 PPD



## M92 AUTOMATIC

This massive 9mm was chosen to replace the .45 auto. Made famous in Operation Desert Storm, this blued "non-firing" metal model actionworks like the original. Can be partially disassembled. L: 8.5" W: 3 lbs.  
#22-1254.....\$102 PPD



**COLLECTOR'S ARMOURY**  
800 SLATERS LANE, DEPT. SO  
BOX 59, ALEXANDRIA, VA 22313

Not sold to Calif. except for theatrical use.

SEND: \_\_\_\_\_  SEND FREE CATALOG  
Credit Card Orders: 1-800-544-3456 Ext. 515

NAME \_\_\_\_\_

ADDRESS \_\_\_\_\_

CITY/STATE/ZIP \_\_\_\_\_

**MONEY BACK (LESS POSTAGE) IF NOT SATISFIED**

# SEMPER MAG

*Continued from page 35*

successful buffer system. (The Royal Ordnance buttstock was selected over the FN wooden buttstock because plastic is more easily decontaminated from NBC agents.) Because of its relatively high cyclic rate, the M240G must use a "hard" buffer. Thus little energy is lost, counter-recoiling forces remain strong, and functional reliability under adverse conditions is high.

Machine guns with lower cyclic rates, like the Bren and M60, can use "soft" buffers which absorb more recoil energy and reduce felt recoil, but drain the available power reserve. The Bren design, along with its adjustable gas regulator needs no additional power reserve. The M60, unfortunately, does.

When the M240G's piston extension reaches the end of its rearward movement, it slams against the buffer block at the front end of the buttstock, forcing it to recoil slightly. The block transfers its movement to a braking cone which penetrates the braking ring, causing it to open. As it expands, the braking ring contacts the interior wall of the buffer cylinder, exerting a braking action through friction. It also moves back, flattening a series of 11 Belleville (saucer-shaped) washers. When this strain energy is released as the washers return to their original shapes, the energy surge throws the recoiling parts forward with almost the same velocity they possessed on contact with the buffer.

The M240G's black plastic buttstock from Royal Ordnance is equipped with FN steel hardware, since the British buffer block is made of aluminum and will eventually crack. The Marines will use the M60's padded sling — which is both excellent and already carried in inventory — with FN swivels.

They intend to deploy the M240G almost exclusively from a tripod. Firing from the bipod will be relegated to "emergency" use only. An emergency is commonly defined as "an unexpected, serious occurrence or situation urgently requiring prompt action."

In my experience, this accurately describes most battlefield environments, so I'm not sure I understand what an "emergency" is to the USMC.

In any event, they have developed a new lightweight version of the M122 tripod (nothing more or less than the M2 tripod used with .30 caliber Browning air-cooled machine guns during World War II and the Korean War — the nomenclature was changed when a new pintle system was adopted for the M60).

Onto this will be placed the newly adopted LTM-M122 flex mount — a lightened version of the FN soft mount as already used with the M240E1 mounted on the LAV (with the 200-round ammunition box deleted). This mount has a spring-buffered assembly to which the gun is attached. By this means recoil is further diminished and the accuracy potential and hit probability at longer ranges are enhanced. The gun's components are also subjected to less mechanical stress. Mounts of this type were designed by the Germans in World War II for the MG34 and MG42 GPMGs. To a considerable degree, they overcome the lightweight GPMG's disadvantages as a long-range, sustained-fire support weapon.

## More Than A Dream Gun

Just how reliable is the M240G? By 1974 the M73/210's incredible deficiencies were apparent to everyone, and tests commenced to find a replacement coaxial machine gun for U.S. fighting vehicles and tanks. The FN MAG 58 was pitted against the M60E2, M219, German MG3, British L7A2, French AAT NF1 (coaxial version of the AAT 52), Canadian C1 (caliber 7.62x51mm NATO M1919A4 BMG) and the Russian PKM. By 1975, all were eliminated except the M60E2 and the FN MAG 58. During the final test phase, heavy emphasis was placed upon reliability. Two criteria were closely examined: Mean Rounds Between Stoppages (MRBS) and Mean Rounds Between Failures (MRBF). Stoppages are malfunctions which require no more than a minute to clear. Failures require more than a minute to clear and usually involve component breakage. The test results were as follows:

Weapon	Rounds Fired	MRBS	MRBF
FN MAG 58	50,000	2,962	6,442
M60E2	50,000	846	1,699
M219 (control)	19,000	215	1,090
Minimum Specified		850	2,675
Minimum Desired		1,750	5,500

Only the FN MAG 58 met the specified minimum. In fact, it even exceeded the "dream sheet" (minimum

# BODY ARMOR THAT STOPS .44 MAGNUMS and weighs only 3-lbs!



SOFT, COMFORTABLE, CONCEALABLE BODY ARMOR MADE WITH 18 LAYERS OF DUPONT KEVLAR (U.S. ARMORS JIA VEST HAS 14 LAYERS, ARMO-TECH HAS 15 LAYERS)

**MED: \$149.99 LRG: \$189.99 XLRG: \$259.99**  
Adjustable ballistic panel carriers available in white, navy, OD and brown.

### 5-YEAR WARRANTY ON BALLISTICS

Prepaid orders include shipping. \$10 charge for CODs. One week shipping for stock sizes. State height and weight when ordering. Money orders and certified checks accepted. CODs cash only.

**MICHIGAN BODY ARMOR**  
P.O. BOX 243 LATHRUP VILLAGE, MI 48076 313-788-2234

## NOTICE TO CALIFORNIA RESIDENTS

Some firearms advertised in this magazine may or may not be lawful for sale in California.

Those specifically not allowed for sale in California are:

### A. All of the following rifles:

1. Automat Kalashnikovs (AK) series
2. UZI and Galil
3. Beretta AR-70 (SC-70)
4. CETME C3
5. Colt AR-15 series and CAR-15 series
6. Daewoo K-1, K-2, Max 1, and Max 2
7. Fabrique Nationale FN/FAL, FN/LAR AND FNC
8. FAMAS MAS223
9. Heckler & Koch HK-91, H-93, HK-94 and PSG-1
10. MAC 10 and MAC11
11. SKS with detachable magazine
12. SIG AMT, SIG 500 Series, and SIG PE-57
13. Springfield Armory BM59 and SAR-48
14. Sterling MK-6 and SAR
15. Steyr AUG
16. Valmet M62, M71S and M78
17. Amalite AR-180 Carbine
18. Bushmaster Assault Rifle (amgun)
19. Calico M-900 Assault Carbine
20. Mandall THE-TAC-1 Carbine
21. Plainfield Machine Company Carbine
22. PJK M-68 Carbine
23. Weaver Am Nighthawk

### B. All of the following pistols:

1. UZI
2. Encom MP-9 and MP-45
3. MAC 10 and MAC 11
4. INTRATEC TEC-9
5. Mitchell Arms Spectre Auto
6. Sterling MK-7
7. Calico M-900

### C. All of the following shotguns:

1. Franchi SPAS 12 and LAW 12
2. Gilbert Equipment Company Striker 12 and SWD Street Sweeper
3. Encom CM-55

**SOLDIER OF FORTUNE MAGAZINE**

desired). The FN MAG 58 coaxial machine gun was type classified in 1976 as the M240. Product improvement continues at FN Manufacturing Inc., and reliability of the MAG series has now been increased to an amazing 26,000 MRBF.

The M60 GPMG is in the process of being removed from U.S. Army inventory. It will be replaced by the M249 SAW. The U.S. Army's 75th Ranger Regiment has decided to adopt the M240G, exactly as fielded by the Marines. Other U.S. military groups are also examining the M240G — both the complete weapon and the parts required for conversion into this configuration.

The Marine Corps and Army Rangers have adopted a battle-proven machine gun that has demonstrated many times the highest possible performance levels in combat from the jungles of Central America to the Negev Desert in Israel. Furthermore, with the M240G, M240 and M240E1, the Marines now have a family of machine guns which are completely interoperable and will greatly simplify logistics, training and maintenance.

Deserts represent an extremely adverse environment for military small arms, more so than even a tropical rain forest or the arctic. During Desert Storm, coalition forces equipped with the MAG series, in any of its variants, fought with a superior machine gun that, when properly maintained, operated with exceptional reliability. It was even reported that the crews of crippled M1 Abrams MBTs pulled their M240s and borrowed the components necessary to convert them into the ground configuration.

Only the dead have seen the end of war. The USMC still has many battlefields to conquer. Marines can be well-assured they have adopted a superb machine gun that will serve them with great distinction far into the foreseeable future. ☒

## THUNDER RANCH

*Continued from page 39*

Having covered the facilities and the quality of instruction, there is another element that contributes to making Thunder Ranch a world-class firearms training center. That element is

.308 WIN.  
SR-25  
STONER RIFLE

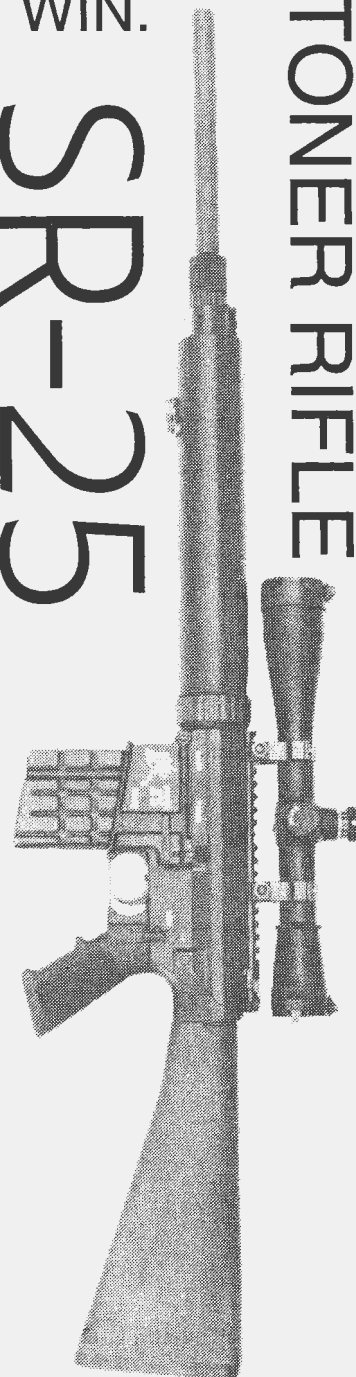

THE 7.62X51mm NATO/.308 WIN. SR-25 SERIES IS THE REBIRTH OF THE LEGENDARY AR-10, BUT WITH 60% PARTS COMMONALITY OF THE BATTLE PROVEN AR15/M16. THE SUB-MOA MATCH MODEL IS DESCRIBED TO BE THE MOST ACCURATE AUTO-LOADER IN IT'S CALIBER. THE STANDARD MODEL IS AN AR15 CLONE WEIGHING UNDER 9 LBS AND FEATURES A REMOVABLE CARRY HANDLE FOR SCOPE MOUNTING CAPABILITIES. SCOPE RINGS ACCESSORIES AND DEALER PRICING AVAILABLE.

**KNIGHT'S MANUFACTURING COMPANY**



DEPT. SF, 7750 9TH STREET S.W.  
VERO BEACH, FLORIDA 32962  
PHONE: (407) 562-5697  
FAX: (407) 569-2955

Save Over 37% Off The Cover Price!

6 Issues Only \$14.95

**Yes!** Sign me up for 1 year (bi-monthly) of FIGHTING KNIVES. I'll pay just \$14.95 and save \$8.75 off the cover price!



Get the latest from the world of combat cutlery!

Enjoy the convenience and savings of having FIGHTING KNIVES delivered to your door.

Each issue cuts through the hype to bring you the real story in bladeaware—before you take it into the field! From applications to accessories, industry updates to product design, FIGHTING KNIVES is committed to bringing you the complete in-depth coverage you need!

So, if you want to stay on the cutting edge and slash costs then a subscription to FIGHTING KNIVES is for you!

Name \_\_\_\_\_

Address \_\_\_\_\_

City/State/Zip \_\_\_\_\_

Payment Enclosed    Charge My     Visa     MC

# \_\_\_\_\_ Exp. \_\_\_\_\_

Signature \_\_\_\_\_

MONEY BACK ON ALL UNMAILED ISSUES IF NOT SATISFIED! Foreign add \$5.00. Make checks payable to L.F.P. Inc. Your first issue will arrive in 6 to 8 weeks. WATCH FOR IT!

OFFER EXPIRES JANUARY 1, 1994

CNWXJ

**FIGHTING KNIVES, P.O. Box 16598, N. Hollywood, CA 91615-9962**

*“He downed four North Koreans before emptying the clip...and then charged, swinging the pistol like a club.”*

# BEHIND THE LINES

**THE JOURNAL OF U.S. MILITARY SPECIAL OPERATIONS**

They're America's elite fighting forces—SEALs, Special Forces, LRRPs, Rangers, Marine Force Recon, Air Commandos. Read about their true-life missions, history, tactics, arms and more. Special warfare by those who fought it. **The Men. The Missions. The Untold Story.** It's all in *Behind The Lines!*



*Subscribe Today!*

**YES!** Send me a TRIAL issue! Enclosed is \$4.

**SIGN ME UP!** for 1 full year, 6 bimonthly issues for \$24 (\$35 foreign).

Name \_\_\_\_\_

Address \_\_\_\_\_

City, State, Zip \_\_\_\_\_

VISA or MC No. \_\_\_\_\_ Exp. Date \_\_\_\_\_

Make checks payable to BEHIND THE LINES, PO Box 456, Festus, MO 63028

SF

the sincerity Clint Smith and his staff bring to this enterprise. As Clint puts it, "We're not here to make a lot of money, we're here to do it right." That attitude is apparent throughout Thunder Ranch, whether you're receiving instruction on the firing line, being coached through the "Terminator," or enjoying the hospitality of the midweek barbecue at Clint and Debbie's home.

A classmate of mine, an employee of the U.S. Department of Energy, commented, "We had the best training facility in the country — now Clint does."

I am inclined to agree. I make my living as a firearms instructor, and when I invest time and money to improve my skills, I want the best training available. In my estimation, Thunder Ranch fills that bill.

Thunder Ranch offers classes for students at all skill levels. For information contact: Thunder Ranch, HCR 1 Box 53, Mt. Home, TX 78058. Phone: (210) 640-3138.

[Watch future issues of *SOF* for a more detailed article about training at Thunder Ranch.]

*A deputy sheriff in Pierce County, Washington, Bill Burris also conducts firearms training statewide for the Washington State Criminal Justice Training Commission and with his own company, Delta International. He has been a regular competitor in the SOF Three-Gun matches since 1986.* ✕

## FULL AUTO

Continued from page 21

release buttons with screw (\$6.95) and Choate folding stocks (\$83.95) for the Marlin Camp Carbine.

Our test specimen was converted to accept Para-Ordnance P14.45 13-round magazines, as this is a pistol which I frequently carry. Operation was flawless. At 25 yards, the group size was about 50% smaller than that produced by a handgun. Hit probability is considerably greater. Depending upon the lead, the Camp Carbine's 16.5-inch barrel will increase muzzle velocity from about 50 to 100 fps. This is not enough to cause most hollow-point ammunition to overexpand and

# TITANIUM

*"The COMPETITIVE edge."*

**\$21<sup>95</sup>** Fits 1911 pistols  
.45 ACP &  
.38 Super

**\$34<sup>95</sup>** Fits AR-15 & M-16

You have already discovered the advantages of our Titanium Firing Pins for 1911 pistols. **NOW YOU CAN ADD THE SAME MAGIC** to your competition AR-15® & M-16®

Improve scores, reduce slam fires, discover what **QUICK** really means! Cut lock time & get on to the next target!

Proudly Made in the USA

**Order desk:**  
1-503-627-9313  
**FAX: 1-503-590-3637**  
(Please add \$3 Shipping & Handling per order)

**Quality Machining**  
INCORPORATED  
"OUR NAME SAYS IT ALL"  
P.O. Box 129 • Sherwood, Oregon 97130

Also available through OLYMPIC ARMS, Inc. Order Desk: 1-206-459-7940

## SWITCHBLADE - AUTOMATIC KNIFE COLLECTORS

### The Automatic Knife Resource Guide and Newsletter

A unique publication for the automatic knife enthusiast, NOW in its **THIRD YEAR!** Terrific photos, in-depth articles, maintenance and repair tips, the **LATEST** trends, resources for ALL kinds of automatic knives, free classified ads and **MORE!** Send \$10. for single issue or \$30. (\$36. Foreign) for one year [4 issues] subscription to: "THE NEWSLETTER" 2269 Chestnut Street, Suite 212-A, San Francisco CA 94123, USA, Phone/FAX: 415 731-0210.

AR15 • MINI 14.30 • M1A • 30 CARBINE • AKS • DAEWOO • FNC

## UNLEASH "HELL-FIRE"™

"INCREDIBLE" Guns Magazine  
"ABSOLUTELY AMAZING" Guns & Ammo  
"BEST LEGAL FULL AUTO" Soldier of Fortune  
"THE BEST" American Survival Guide

Do you own any Semi-Automatic and want to Rock 'N Roll? Have you bought books or toys that didn't work? Well, the all new "HELL-FIRE" Trigger System is here! You won't find anything closer to a "Select Fire" Conversion, **BATF approved** and **LEGAL!** The unit is installed externally in seconds. It does not interfere with the normal operation of trigger. When engaged, you may fire bursts, to emptying complete magazines at a full automatic rate accurately and legally! Hurry and get yours now before it's too late!

Minimum age to order - 18 years

**DOES NOT OBSTRUCT TRIGGER • ALL STEEL • LIFETIME WARRANTY**

SEND YOUR NAME, ADDRESS AND QUANTITY DESIRED TO:  
CASHIER'S CHECK OR MONEY ORDER...  
PERSONAL CHECKS DELAYS ORDER

**HELL-FIRE SYSTEMS INC.** PREPAID  
P.O. Box 549, Olathe, CO 81425  
U.S. Pat. & Other Patents Pending. Colorado Residents Add 3%

**ORDERS ONLY (303) 249-2694**    **FAL • 10/22 • TEC 9, 22 • SP 89 • M1 GARAND • MAC 11/9 • AP 9 •**

under-penetrates in living tissue.

As a complement to your sidearm, the Marlin Camp Carbine, when converted by K.C. Enterprises, provides significantly enhanced performance in a lightweight, fairly compact envelope, whether employed for home defense or as an auxiliary law enforcement weapon. ✕

## FAST-ATTACK SUBS

Continued from page 53

Kuppers and I stood shoulder-to-shoulder behind a Plexiglas splash screen. On the sail above us stood a junior officer and two lookouts; all three wore safety harnesses attached to a railing. This was the best seat in the house. From a perch 25 feet above deck, one could see the sub's bow shoving a wall of seawater ahead. Behind us a thunderous wake spread across the ocean surface.

The sea was rough off Fort Lauderdale. Swells surged 5 to 7 feet high, enough to make even a seasoned hand

green under the gills. Subs are designed to operate in still water, not on the surface where the slightest swells cause them to roll from side to side. When Hurricane Emily smashed into the outer banks of North Carolina last year, the *Key West* took a beating even when submerged 150 feet. She finally descended to 250 feet to escape Emily's fury.

As we moved through the breakers at the entrance to Port Everglades, where tugboats awaited to shove us along to a pier, I couldn't help but notice how *big* this boat was — at 360 feet, it was longer than a football field.

I came to the conclusion that *Los Angeles*-class SSNs were originally designed as weapons platforms, with submariners added as afterthoughts. Otherwise more than two urinals would be available for the *Key West's* coffee-guzzling crew.

*As a senior SOF foreign correspondent, Dale B. Cooper provides readers with grunt-level reporting on many aspects of America's armed services. He also delivered firsthand ground coverage from Somalia and the Gulf War.* ✕

## WORDGAMES

Continued from page 55

U.N. awards, such as the United Nations Medal. The secretary general of the United Nations makes such recommendations directly to headquarters, Department of the Army, which is then responsible for approval/disapproval.

Prior to 5 May 1993, the joint task force for Somalia led by Lieutenant General Johnston (USMC) was responsible for the mission, with the United Nations formally taking responsibility in May. The joint task force worked with Canadians, Belgians, French, Italians and other U.N. forces under the joint task force command and not under the United Nations. There is talk between the United Nations and Department of the Army for a UNISOM medal. It would be up to the United Nations to determine criteria, but historically a trooper must be deployed with the United Nations for six months to be eligible for any U.N. awards; U.S. personnel rotated

# NIGHT VISION



**MPN 95K Generation II Plus  
Weapon Sight**  
60,000X Light Gain (Maximum)  
3.5x Image Magnification.  
Automatic Brightness Control  
\$1295.00

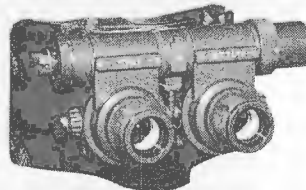

**MPN 50K Generation II Plus**  
50,000X Light Gain (Max.)  
40° field of view.  
Infrared Illuminator  
\$1695.00



**MPN 1500-1 Generation I**  
1,500X Light Gain (Max.)  
2.3X Image Magnification  
Built-in Infrared Illuminator  
See clearly in total darkness!  
\$595.00  
Also available without  
infrared illuminator \$445.00

**MPN 30K Generation II**  
30,000X Light Gain (Maximum)  
2.5X Image Magnification.  
Extremely Rugged Construction.  
Operates on 2 "AA" batteries.  
Starlight Binoculars  
\$695.00



**MPN 60K Generation II Plus**  
Automatic Brightness Control  
5.2X Image Magnification  
60,000X Light Gain (Maximum)  
Sharp, Hi-Contrast Image.  
Uses standard 9 volt battery.  
Can be used with cameras and video.  
\$895.00

30 DAY MONEY BACK GUARANTEE ~ ONE YEAR WARRANTY ~ U.S. SAFETY APPROVED

We carry the entire line of Russian Night Vision Systems, Goggles, Binoculars, Gyro Stabilized Binoculars and Weapon sights, call for information.

All of our Night Vision Systems are brand new, not reconditioned, with new Image Intensifiers for years of dependable service. All units include field cases, batteries and full instruction manuals. These units are made in Russia and are manufactured to Military specifications.

CALL TOLL FREE 1-800-841-3245

Or send check or money order plus \$9.00 S&H to:

**Starlight Imaging Systems Inc.**

17027 West Dixie Highway Suite 103

North Miami Beach, FL 33160

Phone: (305)949-0089

Fax: (305)949-0075



through Somalia every four months.

The mil-speak gremlins strike once again concerning a POW medal for Chief Warrant Officer Michael Durant, the 160th SOAR pilot shot out of the sky during the Olympic Hotel fiasco in October, and then caught and held captive by Somalis for 11 days. The secretary of defense called Durant a "detainee" rather than a prisoner of war; doublespeak backed by a Pentagon that quickly fell back on the old "Congress hasn't declared war" argument in order to describe Durant as a "hostage" rather than a POW.

As a detainee, Durant was never carried on POW status (implying he was being "detained" by a group of Somali citizens rather than by an organized, trained, and highly effective guerrilla army). Obviously the latter is far more accurate given that the Somali counterattack on the Rangers and their limited air support decimated an entire Ranger company and brought down at least two special operations aircraft.

According to O'Keefe, Durant may be authorized his deserved POW medal should a little-known office at Department of the Army offer a legal

finding that he was indeed a prisoner of war. "It would be an exception to policy," observed O'Keefe, who went on to say the media's on-the-spot coverage of how Durant was mistreated in the early stages by his captors would probably embarrass the administration and Pentagon into doling out a POW medal to avoid having to publicly rationalize present mil-speak policy.

American troops killed in Somalia — regardless of date — are not considered by the Pentagon to have been "killed in action." Why? Because such casualties were never in combat as determined by congressional action declaring Somalia a war zone (as opposed to a combat zone); haven't we heard this one before? Purple Hearts are authorized, but Awards and Decorations notes that this is only because President John F. Kennedy issued a special order which provides "that the Purple Heart can be given to a soldier who is wounded while serving with a peacekeeping mission." Really? According to the official narrative for the Purple Heart, it can only be awarded for combat action, and is awarded only to members serving in the United States armed forces.

Numerous men were wounded in Somalia prior to 5 June, many by rocks, bottles and other handy missiles of limited destruction. Several were stabbed, yet none of the above ever received the Purple Heart for their injuries. Bear in mind that in the aftermath of other operations, soldiers have been awarded Purple Hearts because they contracted trench foot or suffered heat exhaustion.

Rationalizing the Pentagon position, O'Keefe stated, "The present mission in Somalia is not to seek out and engage targets. Combat is not involved." According to the sergeant, who is the approving chief for combat awards and decorations and therefore works directly for Lieutenant Colonel Patricia Sigle (who has stonewalled every attempt to see combat recognition considered for the veterans of El Salvador — see "Call To Arms," *SOF* Nov. '93), the mission in Somalia remains as it was originally titled. "It is a peacekeeping, nation building, humanitarian effort only. It is not a combat operation; war has not been declared." Even so, O'Keefe does confirm that as of 5 June, combat awards and decorations have been authorized

## NEW! At last, a SoundScope electronic ear plug

### Imagine being able to do for your hearing what binoculars do for your vision!

You now have a good idea of what SoundScopes can do for you. By increasing your hearing capabilities you can detect your target quicker than you could with your natural hearing. You may even detect game that would otherwise go unnoticed. And, SoundScopes won't interfere with your aiming, movement or other activities. Plus, when you shoot, SoundScopes amplifying action stops, making them perform like earplugs, until the gunfire disappears. Then the amplification resumes.

Let's face it. With today's prices for licenses and equipment, hunters need every "edge" they can get. And SoundScopes can provide that "edge".

**\* Special introductory offer! \***

**\$175.00 + \$10.00 shipping.**

Allow 3 days for arrival. Foreign orders add \$20.00

**1 year unconditional warranty — 15 day return privileges**

**WARNING:** Gunfire is inherently hazardous to your health. SoundScopes are designed to increase your hearing capabilities but do not provide protection beyond that of comparable earplugs. Soundscopes do not guarantee prevention of overexposure to noise. We recommend that you have your hearing tested regularly by a qualified hearing health professional.



**Yes! Please send me a SoundScope at the special price of \$175 each plus \$10 shipping & handling.**

Foreign orders add \$20. Send this coupon with check or money order or supply your MasterCard/Visa info:

Card # \_\_\_\_\_ Expires \_\_\_\_/\_\_\_\_/\_\_\_\_

Signature \_\_\_\_\_

Name \_\_\_\_\_

Address \_\_\_\_\_

City \_\_\_\_\_ State \_\_\_\_\_ Zip \_\_\_\_\_

Phone \_\_\_\_\_

**SOLDIER OF FORTUNE • P.O. Box 693-SSLW • Boulder, CO 80306**



## The Full-Magazine for the Full-Auto Enthusiast

**Subscribe to Machine Gun News Today!**

Each month you'll find an arsenal of information in Machine Gun News: interesting articles, product reports, ammunition tests, industry interviews, legislative updates, shows, and shoot events.

Enjoy regular columns including... *Raffica* - whether it's differences in parts, sources for magazines or functioning problems this column shows you how to find solutions and also tells you what works well

and what doesn't. The *What's New* column features the newest products and accessories. *The Forms* column is your "Guide to the Class 3 World". Plus much, much more.

Subscribe now and take advantage of our introductory discount. The subscription price is \$34.95. But, for a limited time, you can get a year's subscription for only \$29.95. Just use the coupon below. Subscribe and save! To speed your order, call (501) 623-4951.

Yes! Start my subscription to Machine Gun News. I'll receive 12 information packed issues for just \$29.95!

M/C, Visa, AmEx # \_\_\_\_\_

Exp. \_\_\_\_\_

Check/Moneyorder enclosed

To ensure your privacy **Machine Gun News** is mailed with a protective cover.

Watch for your first issue in 4-6 weeks!

name \_\_\_\_\_

address \_\_\_\_\_

city \_\_\_\_\_

state \_\_\_\_\_ zip \_\_\_\_\_

**Send to:** Machine Gun News  
P.O. Box 759, Dept SF02,  
Hot Springs, AR 71902  
**Or call:** (501) 623-4951.

**Fax order line:** FAX5016239832.

despite war not being declared and combat operations being a no-no. Well, at least not offensive combat ops ... or is it defensive ops ... or does anyone really know at this point?

Near as we can tell, the recent awarding of the CIB is to reward those infantry/special operations troops who became involved in an offensive/defensive operation where the immediate mission was to seek out and close with the enemy, and to destroy him ... but only in protection of noncombatants involved in the humanitarian mission, so that all hostile actions served to protect "the force" and those associated with the peace effort, who might be termed as the "non-force." *Excuse me?*

### Offensive Combat Or Combat Offenses?

In reaction to criticism of the Pentagon's politically correct semantics, O'Keefe accused both authors of this article (and others concerned with the issue of appropriate recognition) of "trying to make something out of nothing" and "attempting to credit yourselves as combat veterans when you aren't." O'Keefe, whose closest brush with combat appears to have been having a brother in an artillery outfit in Vietnam, offered that "just because Staff Sergeant Zimmerman had to go down an alley and kill some people" doesn't mean he was involved in combat if combat wasn't the official title of the mission; further, that former SSgt. Walker clearly broke either the law or the rules of engagement in El Salvador if he indeed took part in an "offensive combat operation."

The good sergeant bases this belief upon the comments of two Army colonels who told him they'd served in El Salvador but only as trainers, never as combatants. "El Salvador was a training mission," stated O'Keefe, "and we don't reward soldiers who break the rules."

This in spite of the fact that abundant military documentation clearly shows the reality of combat for U.S. advisers in El Salvador.

In both Somalia and El Salvador we and our troops were fighting for our lives against an armed and determined enemy who was intent upon killing us whenever the opportunity presented itself. Any soldier who has served in combat will agree that the experience of a combat environment,

# FIGHTING FIREARMS

Published twice a year by Omega Group Ltd., **Fighting Firearms** covers the latest developments in **small-arms technology** and **firearms employment tactics**. Edited by **Soldier Of Fortune's** Technical Editor **Peter G. Kokalis**.

Targeted at the **hunting, law enforcement** and **military** markets, **Fighting Firearms** is the only forum for new, in-depth, up-to-date information for the growing number of paramilitary firearms users and enthusiasts.

At your local newsstand or send \$5 to **Soldier Of Fortune**, P. O. Box 693, Boulder CO, 80306 ATTN: Helena

**ON SALE**  
**2/8/94**

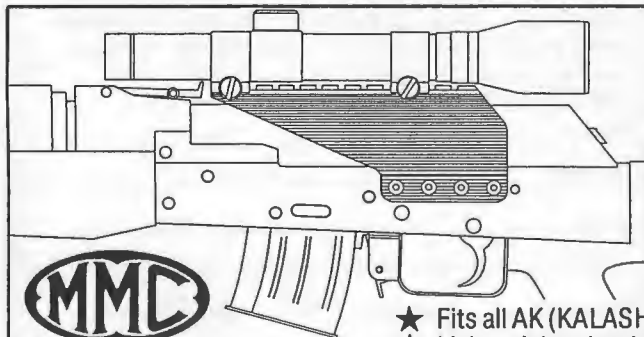

**MMC**  
**UNIVERSAL**  
**AK SCOPE**  
**MOUNT**  
**39.95**

- ★ Fits all AK (KALASHNIKOV) type firearms
- ★ Lightweight, ultra low profile & rigid
- ★ Unobstructed view of iron sights over mount
- ★ Field stripping capabilities retained with scope and mount in place



MINIATURE MACHINE CORP.  
606 Grace Avenue-SOF  
Ft. Worth, Texas 76111  
(817) 831-0837

24 hours a day, seven days a week is unlike any other. Furthermore, those who have been forced to kill another human being — declared “enemy” or not — will live with this memory for eternity.

Combat awards and decorations, more than anything else, assure the trooper he did the right thing in defense of his nation’s interests, or in defense of his comrades or himself. To not formally acknowledge such actions is to demean both the profession of combat arms and the men/women who carry a rifle rather than a briefcase.

### Peacekeepers Bleed Too

Army Awards and Decorations spokespersons may be of the opinion that if a soldier engaged in combat in El Salvador, he was wrong. If a soldier engaged in offensive operations in Somalia, he, too, was wrong — but neither author believes the reader will find a senior ground commander from either conflict who would support this ignorant observation.

Lieutenant Colonel James F. Sikes, a battalion commander with the joint task force in Somalia, has stated his belief that all troops in the task force earned and deserve CIBs and CMBs (Combat Infantryman’s Badge, Combat Medical Badge) regardless of the arbitrary date arrived at by Central Command. “Everything we did,” said Sikes, “was treated as an offensive operation in order to keep the Somalis off balance.”

From the war in El Salvador comes a similar observation, again by a senior combat commander, retired general and former Southern Command commander in chief, Maxwell R. Thurman: “U.S. personnel assigned and or attached to the U.S. Military Group El Salvador performed outstandingly ... There were countless incidents where U.S. personnel were taken under direct and indirect fire and where enemy troop units moved within meters of U.S. personnel ... They were constantly exposed to enemy fire and consciously executed their mission with such valor, professionalism, and dedication to duty that the Salvadoran armed forces were able to achieve a significant victory. The level of danger they encountered was consistent with what U.S. personnel with similar responsibilities have faced during recent periods of armed hos-

tilities worldwide.”

But at the Army’s Awards and Decorations Branch, these words continue to fall upon deaf ears. And the word games go on and on and on ...

*SSgt. John K. Zimmerman served with the 10th Mountain Division as a scout sniper in Somalia. Greg Walker is a veteran of the war in El Salvador, and SOF Contributing Editor for “Battle Blades.” ✕*

## CHIMOIO

*Continued from page 47*

choppers and was advised that they were only 10 minutes away and that all my men would be taken out in one lift. Seconds after the helicopters arrived they were airborne again, carrying our group of happy troopers straight back to Rhodesia. Back at New Sarum by 1010 hours, we were fed a superb steak-and-egg breakfast by the air force mess. Then we showered, changed clothes, cleaned our weapons, exchanged maps and air photos, and got our orders for the attack on Tembue, even farther inside Mozambique. The next morning the SAS and a different group of RLI paras climbed into the Daks and flew off to do the whole thing over again.

The capture and destruction of Chimoio was the most successful operation of its type during the Rhodesian war. Never again would there be such a concentration of terrorists in one place, concurrent with political and military situations allowing them to be attacked. By destroying Chimoio and Tembue, the Rhodesians convinced Mugabe and his sponsors that a political settlement would be easier to achieve than a military victory. At Chimoio, a tiny force of less than 300 combatant soldiers and airmen (plus their legions of support personnel) had routed an entrenched foe whose strength was finally confirmed to be over 8,000. The same size Rhodesian force did the same thing two days later at Tembue, driving 4,000 more ZANLA from the base, killing another thousand or so in the process. Total Rhodesian casualties were less than one dozen men killed and wounded.

*Continued on page 82*

# Mounts

## FN-FAL/LAR



- Replaces gun's dust cover
- Clamps to receiver for rigid no movement mounting
- Standard Dovetail base
- Complete with 1" rings

## AR 15/16 NATO See Thru



- Attaches to the gun's handle by a large thumb screw knob
- Base is removed and installed without zero change
- Standard Dovetail base
- Complete with 1" rings

## SKS 56 Receiver



- See-under type so gun's sights can be used
- Attaches to receiver by replacing cover retaining pin
- Standard Dovetail base
- Complete with 1" rings

## No Gunsmithing

Ask your Dealer or Call

**1-800-433-2909**

**B SQUARE**

P.O. Box 11281, Fort Worth, Texas 76110



## Brand - New Military NIGHT VISION

FROM ONLY \$450.00!

Great for hunting, boating, fishing, security, search & rescue and survival or just plain fun.

- Military starlight technology
- Originally manufactured for the Russian KGB
- Full One-Year Warranty
- Immediate delivery available
- Compare our Low Prices!
- Call for a free full-line catalog
- Major credit cards accepted
- 30-day money back guarantee



**BN-453 Starlight**  
(3.2x Magnification)  
Only \$545.00!

**RN-M01 Starlight**  
(2.6x Magnification)  
Only \$795.00!

Plus \$12.00 S&H. Californians add 7.75% sales tax  
**Order Now: 1-800-428-7825 x313**  
or fax orders to: (714) 497-4683

**M·O·R·O INTERNATIONAL**  
219 BROADWAY, SUITE 307 LAGUNA BEACH, CA 92651

**Thompson**  
TM

**.45 ACP,  
.40 S&W,  
.38 super,  
9mm, 10mm.**  
Auto-Ordnance has a complete line of 1911A1 pistols in assorted models and calibers. Contact your dealer or send \$3.00 for color catalog.

**Auto-Ordnance Corporation**  
Box SF-02, West Hurley, N.Y. 12491 (914) 679-7225

## LILE HANDMADE KNIVES

**"ARKANSAS KNIFESMITH"**  
Excellence since 1970

Designer & Maker  
**FIRST BLOOD & RAMBO**

**Deathwind Hunter or Military**

**Deathwind Hunter or Boot**

Visa & Mastercard - also Lay-away  
2721 S. Arkansas Avenue  
Russellville, AR 72801  
501-968-2011 Fax 501-968-4640

Don't get fooled by Frauds  
**100% GUARANTEED**  
Anabolic Muscle Building

# STEROIDS

Replacement

This product is to be taken **orally**.  
No harmful side effects.

S&K Performance Product **Boron!**  
Can dramatically increase your **Testosterone levels up to 300%!**  
Higher Testosterone means faster, easier muscle growth! Greatly enhance your physical appearance literally sculpting your own body with huge healthy, hard muscle.

Get that lean awesome body builder physique now with one 3 month cycle for only **\$15.95!**

If you are not completely satisfied with the growth you obtain within 15 days return it for a full refund.

**Money back guarantee!** To get your super anabolic growth cycle from:  
S&K Performance Products

Order Now!!!  
MasterCard \$15.95+shipping VISA  
**1-800-398-6946**  
24hrs. 7 days a week  
C.O.D.'s welcome add \$4.00 shipping.  
Check or money order send with \$15.95+shipping and handling to:  
S & K Labs, 2637 E. Atlantic Blvd. Suite 101,  
Pompano Beach, FL 33062

## At Your Command

Take charge with U.S. Cavalry's high-quality military, outdoor and adventure merchandise. Over 100 full-color pages including official military uniforms, knives, survival and camping gear, working collectable firearms, target practice aids, personal protection devices, binoculars, and much more. For a catalog, send your name, address and \$3.00 to

Name: \_\_\_\_\_  
Address: \_\_\_\_\_  
City: \_\_\_\_\_  
State: \_\_\_\_\_ Zip: \_\_\_\_\_

**U.S. CAVALRY**  
WORLD'S FINEST MILITARY AND ADVENTURE EQUIPMENT

DEPT. SF  
2855 Centennial Ave. Radcliff, KY 40160-9000

**We offer the largest selection of BDU's of anyone!**

100% Cotton Rip Stop: Navy Blue, Black, Grey, Olive Drab, Tiger Stripe, White, Woodland Camo — \$29.95 ea. 50/50 Fabric: Urban Camo (with white), Subdued Urban Camo (No White), Black, Navy Blue, 6-Color Desert, and 3-Color Desert \$29.95 ea. (Woodland Camo \$26.95 ea.) Brown Realtree with lead \$34.95 ea. Blaze Orange \$33.95 ea. XXL add \$4.00; XXXL add \$6.00

- Anorack/Pullover Parka: Woodland Camo, Tiger Stripe, Black, Navy Khaki, Off-White, Olive Green, Trebark, 6-Color Desert and 3-Color Desert ..... \$39.95 (Brown Realtree with Leaf Camo) ..... \$46.95
- Olive Drab Jungle Fatigues Cot. Rip Stop (Slant Pocket) ..... \$29.95
- Two Pocket Tuck-In BDU Shirt (Black, Woodland Camo, Navy, Khaki) ..... \$29.95
- Hi-Tec Super Magnum Boots (Black) ..... \$73.95
- Hi-Tec All Leather Super Magnum Boots (Black) ..... \$78.95
- Desert Storm Boot (Tan). Official Issue ..... \$49.95
- G.I. Quick Lace Combat Boot ..... \$58.95
- Speedlace Jungle Boot (Black) Official Issue ..... \$59.95
- Traditional Olive Drab Jungle Boot ..... \$56.95
- Commercial Jungle Boot (Black, Olive Green and Woodland Camo ..... \$29.95
- Large G.I. Field pack with Frame ..... \$116.90
- Military Shorts — Seals, Army, Navy, AF, U.S.M.C. ..... \$15.95
- Gerber Stainless Multiplier Tool ..... \$58.95 (Black) ..... \$63.95

Mail proper amount plus \$4.95 (double for Canada) (TN residents add 8.25% sales tax) for shipping & handling to:  
**GREENE MILITARY DISTRIBUTORS, INC.,**

7215 Kingston Pike, Dept., SF, Knoxville, TN 37919  
• ORDER TOLL FREE 1-800-521-7977 in TN (615) 588-5945 Satisfaction Guaranteed or Your Money Back

## Health is cheap, Disease is expensive!

Have you noticed how much the world has speeded up lately? The demands on our time and our physical bodies has increased dramatically. Whether we walk or run, work or play, our bodies are in constant motion. Perhaps the body has slowed a little. Since the one thing that the body spends most of its energy on is digestion--simply learning about food combining can provide you with more energy, vitality and a better looking body. Invest \$5.00 for information on how to have a more well-nourished body that the Chinese have known about for thousands of years!

**Lose weight! Look great!**

**DO IT NOW!**

Name \_\_\_\_\_  
Street \_\_\_\_\_  
City \_\_\_\_\_ State \_\_\_\_\_  
Zip \_\_\_\_\_

Clip & Mail to: Zen Health Products  
576 Aztec Drive  
Boulder, CO 80303

Ck Money Order (Payment must accompany order.) 0294



## 300 WHISPER

SSK's AR-15/M-16 UPPER RECEIVERS and the 300 WHISPER convert your rifle to 30 caliber. It works in high and low velocity mode without adjustment. The gun will operate at subsonic velocities (1040 fps) with 168, 180, 190, 200, 220 and 240 grain bullets. Loaded with high velocity ammunition, it will push a 125 grain at 2400 fps, 150 at 2100, 168 at 1900, 190 at 1750, 220s at 1500 and 240s at 1400. Simply pop your upper unit off and install ours. No changes necessary. Amazing accuracy with all bullet weights. Factory ammo available. AR-15 uppers, bolt action rifles, T/C barrels, and suppressors all ready to go.

300 WHISPER is a proprietary cartridge invented by J. D. Jones. All NFA rules apply.

ILLUSTRATED BASIC DATA-LOAD DATA \$3.00 (Refunded with purchase)

**SSK INDUSTRIES**  
721-SOF Woodvue Lane  
Wintersville, OH 43952  
Telephone 614/264-0176  
Fax 614/264-2257



# FREE!

## Discount Knife Catalog

- Save up to 50% or more
- Huge selection
- Top quality--no seconds
- Fast service
- Satisfaction guaranteed!

**Cutlery Shoppe**

5461 Kendall Street Dept. SF  
Boise, Idaho 83706-1248  
Phone: 1-208-376-0430  
Fax: 1-208-376-7608

## MOVING?

PLACE LABEL HERE

MR/MRS \_\_\_\_\_ Apt. No. \_\_\_\_\_  
Street \_\_\_\_\_  
City/State/Zip \_\_\_\_\_  
Phone \_\_\_\_\_

Mail to: SOLDIER OF FORTUNE Magazine,  
P.O. Box 348, Mt. Morris, IL 61054

# GENUINE BRITISH MILITARY KIT

- BRITISH DPM SAS SMOCKS
- BRITISH DPM PARA SMOCKS
- BRITISH DPM JACKETS ('68 PAT)
- BRITISH DPM TROPICAL SUITS
- BRITISH WOOLEY PULLY'S
- BRITISH DENISON SMOCKS
- BRITISH WEBBING PLCE, '58, '37
- BRITISH DPM DESERT SUITS
- BRITISH RUCKSACKS
- BRITISH DRESS UNIFORMS
- BRITISH POLICE KIT
- BRITISH PARA/SAS BERETS/BADGES
- BRITISH G10 ARMY WATCHES
- BRITISH W.W. II KIT



Orders dispatched by air mail £17.99 per order Visa/MC accepted.

Send for FREE catalogue to : Silverman's (SOF), Mile End, London E1 4PS. England  
Phone 01 1-44-71-790-5257  
Credit card orders 0717-900-90  
Fax 011-44-71-791-0008

NAME \_\_\_\_\_  
ADDRESS \_\_\_\_\_  
CITY \_\_\_\_\_  
STATE/ZIP \_\_\_\_\_

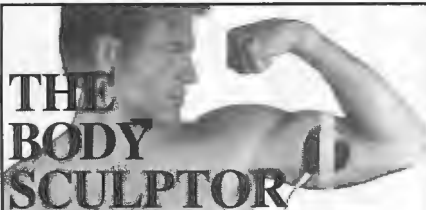

## THE BODY SCULPTOR

Develop the body you've always dreamed of having. Add inches to your chest, arms, and thighs. Sculpt your stomach, buttocks, and calves. The Body Sculptor tones muscles, and relieves stress and tension. Adjustable electrical impulses work your muscles more effectively than regular exercise. It's medically proven, effortless and safe! Use it at home, in the office, traveling, even while reading or watching T.V. Results guaranteed in 30 days or your money back!



Your unit includes the following: • 24 hr. customer service • Free AC wall adapter • Complete instructions • 5 year Iron-Clad warranty • Free Carry Case • 30 day trial period

A. BM-1004, 6-pad model w/AC adapter, \$219  
B. BM-1006, 8-pad model w/ AC adapter, \$259  
C. BM-1008, 12-pad model w/AC adapter, \$359  
D. BM-1012, 16-pad model w/AC adapter, \$459  
E. BM-1014, 18-pad model w/ AC adapter, \$499

\*Add \$10 for ship. & handling • CA res. add 7.75% tax  
Call Now For Immediate Delivery!  
1-800-428-7825, Ext. 33 (U.S. & Canada)  
or send check/money order to: David Steele  
64 Lehigh Aisle, Irvine CA 92715

These Are The Finest Electronic Muscle Stimulators Available Anywhere!

## BULLETPROOF VEST

Will stop the .357 Magnum, 9mm and 00 Buck. Meets and exceeds "Threat Level II-A" tested in accordance with the NILECJ-STD-0101.01. Weighs 2¾ lbs. Fits easily under T-shirt.



Front & Back Protector \$220  
Detachable Side Panels \$45  
Chest Trauma Plate \$35

Officially tested by the U.S. Government Edgewood Arsenal at the Aberdeen Proving Grounds under the U.S. Department of Justice Standards. State height, chest and waist measurements.

**MATTHEWS POLICE SUPPLY CO.**  
(a division of David Matthews, Inc.)  
P.O. Box 1754 Dept. SF  
Matthews, N.C. 28105  
Ph. (704) 847-8793 FAX: (704) 847-4447

# PRIVACY ?

**Avoid BIG BROTHER.**  
Best techniques for creating COMPLETE PRIVACY!

- Avoid Surveillance, Eavesdropping
  - Become "Invisible" to Investigators
  - Stop Generating Financial Records
  - Communications Privacy . . . Phone, Mail
  - How to Stay Out of Government Files
  - Begin Eliminating Negative Records
  - How to Create Helpful New Records
  - Generating Quick Cash Income
  - Hiding Your Assets ■ Privacy Aloft
  - Banking Alternatives ■ "Low Profile"
  - Privacy from Taxes ■ Nomadic Living
  - Multiple Addresses
  - Hideouts, Deep Cover
  - How to "Disappear"
- ALL THE PRIVACY YOU WANT — and MORE!  
Visa/MC: 800-338-8484

**ONLY \$18.95**

EDEN PRESS  
11623 Slater "C", Box 8410-AP Fountain Valley, CA 92728

Your Choice  Regular P&H, \$3.00 (Please add to order.)  
 FIRST CLASS, \$6.00 (Please add to order.)  
(California residents please add 7.75% sales tax.)  
 Send latest Book Catalog — FREE.

Name \_\_\_\_\_  
Address \_\_\_\_\_  
City \_\_\_\_\_  
State \_\_\_\_\_ Zip \_\_\_\_\_

See our collection on color VIDEO

**SUB IRON CROSS WOUND**  
Your choice any one-\$10.00 or all 3-\$25.00. All are full size, not miniatures. These made from originals. Your choice WWI or WWII (state choice). We have most complete stock of WWII German badges-caps, etc. in U.S.

**WWII U.S. CAP**  
U.S. Officer's Cap (new from original U.S. maker). Tan with brown leather visor, chin strap and U.S. Eagle pin. State size S, M or L, \$68.00. Have few Olive Drab, Wool \$74.00

**GENERAL'S CAP**  
State S, M or L Size-\$88.00. Shoulder Boards, Set-\$31.00. Collar Tabs, Set-\$18.00. Complete, Knights Cross-\$21.00. The Complete Set, IN STOCK. ALL 4-\$137.00

**AFRIKA-KORP. CAP & GOGGLES**  
German 1942 Mfg. ORIGINAL sand & dust goggles. Still in their pocket pouch. Tan O/c. caps=New REPLICAs. State S, M or L size, Both Only \$39.00

**U-BOAT CAPTAIN'S CAP**  
White top Gold insignia and visor braid. Leather chin strap. State size wanted \$110.00 Knights Cross with ribbon and oak leaf with swords \$21.00

**PANZERFAUST ANTI-TANK WEAPON**  
Full Size Movie Makers Replica \$165.00+ \$10.00 handling

For the back or your jacket... Flying Tigers BloodChit Patch 7" X 11" good reproduction-\$25.00 (your choice of American or Chinese flag).

VIDEO - our collection w/prices... on VHS VIDEO only \$20.00 postpaid. Free w/any \$25.00 + order.

W.W.#2 Ltd. Box 2063-F St. Louis, Mo. 63158

**JOIN WAR ON CRIME AND MAKE BIG MONEY!**

Buy direct from manufacturer: stun guns, pepper sprays, stun batons, personal alarms, portable door locks, counterfeit detector pens and more!

**Before You Buy, Price Us First**

1867 Caravan Trail #105  
Jacksonville, FL 32216  
1-800-477-1739  
904-720-2188  
FAX (904) 720-0651

Safety Technology

**LEGIONNAIRES SURVIVAL BOOT KNIFE**

ONLY \$12.95  
Add \$1.05 Hndl.

Model K-99-A

Double edge 440 stainless steel blade. Full tang one piece construction. Leather sheath with quick release snap and metal boot/belt clip. **Money Back Guaranteed If Not Fully Satisfied!**

WESTBURY SALES CO. DEPT BK-02-SF  
156 Post Avenue, Westbury, New York 11590

**MILITARY NIGHT VISION RIFLE SCOPES**

**BRAND-NEW \$995!** Plus \$12.00 S&H  
FROM ONLY

Compare with U.S. units selling brand-new at \$5,000.00 and more!

Own the Starlight technology used by the KGB, Russian Commandos and Military for night surveillance and combat! **Feather light; U.S. mount; adjustable windage & elevation; optional infrared illuminator pin-points targets with invisible light!**

Investigate our full line of superior-quality, low-cost Night Vision devices.

**30-Day Money-Back Guarantee!**

Use of this product for hunting & other activities may not be legal in your area  
Californians add 7.75% sales tax

Call Now: 1-800-54-NIGHT

**HITEK**

490 El Camino Real, Redwood City, CA 94063

**Pro-American T-Shirt Designs**

100% Cotton, White, Heavy Weight Made in USA T-Shirts

Sizes: S-M-L-KL \$12.00 ea. + \$3.00 S&H

Sizes: 2H & 3HL \$14.00 ea. + \$3.00 S&H

If you MUST burn a flag, Burn One Of These! (Design #1)

**AMERICA Strong, Proud And FREE!** (Design #2)

**Always Buy "American Made" The Job you save, may be "YOUR OWN"** (Design #3)

Multi-Color Designs, Screen Printed. Catalog \$3.00 (Refundable)  
State Design #, And Size. With Order. Allow 2-4 Weeks Delivery  
Mail to:  
Motion Graphics  
P.O. Box 112080  
Campbell, CA. 95011  
CA. Residents Add 8 1/4% Sales Tax  
Dealer Inquires Invited

**STEROIDS**

**D-BALL TEST JET DECA**

Anabolic Steroids increase Testosterone levels to Build Muscle Mass and Strength

Now there is a safe and effective replacement for steroids, **Boron\***. Tens of thousands have used **Boron** from JTR Labs to successfully replace steroids without the harmful side effects. *Guaranteed*. Check out these results. All from **Boron** users.

"...200 pounds of muscle in three months..." Willie Beck III. AL  
Terry Goetz from VT put 90 pounds on his bench.  
"...two inches in my chest..." John Ramsey. TX  
"...its the extra edge I needed..." Charles Walters, Military  
*All these amazing gains using Boron.*

For your own Huge Increases - Order your 3 month cycle of **Boron** today. Only \$19.95, shipping included. Blow away your competition and order now.  
\*Boron is a safe, 100% natural nutrient

**COD's, Credit Card, Catalog orders call: 1-800-962-4769....ask for dept.#581**  
Order lines open 24 hours 7 days a week  
Send check or money order to:

JTR LABS  
10230 Bach Blvd.  
Dept.#581  
St. Louis, MO 63132

**MONEY BACK GUARANTEE**

WARNING: Accept no imitations or copy cats. JTR Labs, gives you the highest quality Boron. For 5 years. Unlimited Guarantee.

**CAPITALIZE ON CRIME**

**IT CAN PAY HUGE PROFITS!**

CRIME PREVENTION IS A MULTI-MILLION DOLLAR BUSINESS!!

OUR DEVICES SELL LIKE CRAZY!

WE SELL SECURITY PRODUCTS WORLDWIDE.

**EARN HUNDREDS DAILY!**

**FREE WHOLESALE CATALOG**

WE CARRY THE BEST LINE OF SECURITY SPRAYS, STUN GUNS, PERSONAL SOUND ALARMS, BURGLAR ALARMS AND MUCH MORE. WE SPECIALIZE IN OFFERING THE BEST SECURITY PRODUCTS AT THE VERY BEST WHOLESALE PRICES. \$3.00 S&H.

**KEY CHAIN SPRAYER**  
RETAILS: \$19.95  
SAMPLE: \$9.95

**POCKET PEN SPRAYER**  
RETAILS: \$14.95  
SAMPLE: \$6.95

**PERSONAL SOUND ALARM**  
130 DECIBELS  
RETAILS: \$39.95  
SAMPLE: \$14.95

**ELECTRONIC STUN GUNS**  
RETAILS: \$69.95  
SAMPLE: \$29.95

**INFRASONIC BURGLAR ALARMS**  
RETAILS: \$429.00  
SAMPLE: \$249.00

**CALL OR WRITE TODAY!**  
WE ARE COMMITTED TO YOUR SUCCESS. CRIME DOES NOT WAIT! WILL YOU?  
**L.A. LAW ENFORCERS**  
1005 No 1st St., Dept. SOF  
Yakima, WA 98901  
(509) 457-9033 FAX (509) 575-1875

## THE HOUND DOG

### Sniffs Out Hidden Transmitters

Throughout the world today, corporations, professional men, and businessmen are spending millions annually to insure privacy in their offices and homes where important plans and policy making decisions are discussed and formulated. The "HOUND DOG" is a wise investment for anyone who has reason to believe that an eavesdropping device is now hidden, or may be hidden in the future, in either home or office. No radio transmitter, no matter how well it may have been hidden, can escape detection by the "HOUND DOG".

The "HOUND DOG" is an advanced electronic instrument designed for the sole purpose of locating hidden transmitters. An average size office or room can be thoroughly searched in only a matter of minutes. The "HOUND DOG" sniffs out any transmitters hidden in pictures, walls, desks, chairs, etc., regardless of their operating frequency.

The "HOUND DOG" is simple to use. Single knob adjustment calibrates the meter and any transmitter signal received is indicated by the meter movement. By simply sweeping the probe past walls, chairs, pictures, desks, etc. the presence of any transmitter will cause a rise in the meter reading. The meter reading will continue to rise as the probe approaches the transmitter.

We believe you will find the "HOUND DOG" outperforms most other units selling for several times the price. This item has been built since 1962. Each one is backed by a 3-year warranty by us.



SIZE . . . 1.6 x 2.4 x 8.2 INCHES **\$195.00**  
USES A COMMON RADIO BATTERY

### Super Powerful FM TRANSMITTER

Many times more powerful than other transmitters. Transmits up to 1/4 mile to any FM radio — Easy to Assemble Kit — up to 9V battery (not incl.)

**\$19.95**

Call 407-725-1000 or send \$195.00 plus \$5.00 shipping for Hound Dog and \$19.95 and \$1.00 shipping for FM Transmitter to USI Corp., P.O. Box SF-2052, Melbourne, FL 32902. COD's OK. For a catalog of transmitters, voice scramblers & other specialty items enclose \$2.00 to USI Corp.

## U.D.T. "The Combat Divers"

Commentary by:  
Commander Francis "Fearless" Douglas Fane, USNR



See how NAVY SEALS were born!!!  
1st Rebreather, Torp Tube Exit, Capsule Recovery  
An incredibly entertaining video  
documentary detailing the history of SCUBA &  
Naval Special Warfare.  
Meet the creators of today's Navy SEALs!  
Send \$30.00 Chk/M.O. To: Shogunite Inc.  
Suite 103-360  
10 E. Palmetto Pk. Rd. Boca Raton, Fl. 33432  
For FAST! UPS/COD Call 1-305-753-6692

## GUN PARTS CORPORATION

SUCCESSORS TO NUMRICH ARMS

### THE WORLD'S LARGEST GUN PARTS SUPPLIERS PRESENTS ITS NEW #18 CATALOG

Featuring an inventory of over 450 million gun parts we have for sale. A 650+ page catalog with exploded drawings that are invaluable to the gunsmith or hobbyist. Commercial, military, antique and foreign gun parts (many exclusively available from us) are listed and priced along with accessories, surplus & specialty items. A veritable encyclopedia of gun parts, this catalog will pay for itself time and time again with information and time saved in identifying parts.

U.S. \$5.95 SURFACE FOREIGN - \$10.95  
send AIRMAIL WRITE FOR QUOTE  
GUN PARTS CORP. BOX SF0294, W HURLEY, NY 12491  
914-679-2417 FAX 914-679-5849

## PHOTO CARD KITS

MONEY BACK GUARANTEE!

Our Professional quality, laminated photo cards will amaze your associates! We provide the cards, plastic laminate and easy instructions! You provide only a photo. Your photo Card can be finished in the privacy of your home! The result is a distinctive, professional system! The highest quality cards in the US! Lost your original card? Replace it now!



only \$4.95 C203 Bail Enforcement Agent

Select From These Kits:

- |   |   |
|---|---|
| C04 <input type="checkbox"/> Bounty Hunter          | C06 <input type="checkbox"/> Mercenary            |
| C13 <input type="checkbox"/> Special Investigator   | C41 <input type="checkbox"/> Intelligence Officer |
| C45 <input type="checkbox"/> MAC-V (CIA), #1        | C212 <input type="checkbox"/> Official Press      |
| C60 <input type="checkbox"/> MAC-V(CIA), #2         | C46 <input type="checkbox"/> Special Forces       |
| C14 <input type="checkbox"/> OCB                    | C47 <input type="checkbox"/> Seal Team            |
| C52 <input type="checkbox"/> Air America Pilot      | C18 <input type="checkbox"/> Pilot                |
| C01 <input type="checkbox"/> Press Card             | C03 <input type="checkbox"/> Security             |
| C50 <input type="checkbox"/> Phoenix Program        | C17 <input type="checkbox"/> Int'l Drivers Permit |
| C49 <input type="checkbox"/> Delta Force            | C11 <input type="checkbox"/> Private Investigator |
| C25 <input type="checkbox"/> Parachutist, Certified | C02 <input type="checkbox"/> Bodyguard            |
| C26 <input type="checkbox"/> SCUBA, Certified       | C12 <input type="checkbox"/> Security Consultant  |
| C07 <input type="checkbox"/> Weapons Specialist     | C51 <input type="checkbox"/> Special Operations   |

Any Three Only **\$11.95**

Any Six Only **\$19.95**

**NIC Law Enforcement Supply**  
500 Flourney Lucas Rd. Box 5950-SV  
Shreveport, LA 71135-5950

COLOR CATALOG \$2.00 OR FREE WITH ORDER

Name \_\_\_\_\_  
Address \_\_\_\_\_  
City/State/ZIP \_\_\_\_\_  
Card # \_\_\_\_\_ Exp. Date \_\_\_\_\_  
 VISA  M/C  CHK  MO 24-hour order No. (318) 688-1365  
FAX # (318) 688-1367

## N.A.I.T INDUSTRIES ELECTRO-OPTICS

### U.S. THIRD GENERATION NIGHT VISION SYSTEMS

NEW FROM FACTORY WITH ONE-YEAR WARRANTY

#### PVS-7B

Gen III  
1X Lens  
I.R. Light  
Case/  
Headstrap



**\$3,995.00!!! \$3,450.00!!!**

N.A.I.T. offers a complete line of over 100 models of I, II, III Gen Systems. We pride ourselves in providing quality systems to fit your specific needs. Reconditioned units are available at over 50% savings to you! For example...

#### PVS-7A

Gen II & III  
I.R. Light  
1X Lens



Starting from **\$1,995.00!!!**

#### PVS-5 A,B,C

Gen II  
I.R. Light  
1X Lens  
Headstrap



Starting from **\$2,495.00!!!**

Over 25 different scopes to choose from!  
N.A.I.T. INDUSTRIES' overhaul facilities can accommodate repairs, modifications, upgrades, and retrofits for most night vision systems.

Send \$1.00 for a catalog to:

NORTH AMERICAN INTEGRATED TECHNOLOGIES

1911 Douglas Blvd., Suite 85-104  
Roseville, CA 95661  
(916) 784-3316 INFO (916) 774-7525 ORDERS

## SPECIAL FORCES



### PARA + SCUBA T-SHIRT

"The best looking military T-shirt I've ever seen."  
- N.K. Green Beret Combat Diver

Join the Elite Sharkmen with this exceptional FULL COLOR Special Forces Para-Scuba T-shirt. A super high quality design printed on the front of white 50/50 Hvyweight T-shirts. Specify size: L or XL. These shirts are an exclusive offer from MIW DESIGN. so don't miss out!

\$19 per shirt + \$3 shipping

Quality Crafted in the U.S.A.!

Send Check or Money Order to

MIW DESIGN  
Dept. 351 • 7 Manton Terrace  
Boston, MA 02134-4505  
(617) 731-6614

30 Day money back guarantee

## Be a DETECTIVE

SPECIAL SOF PRICES! AND EARN YOUR BADGE  
NO EXPERIENCE NEEDED

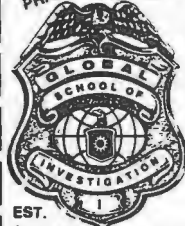

MEN - WOMEN  
TRAIN AT HOME FOR AN EXCITING PART OR FULL-TIME CAREER AS A PRIVATE DETECTIVE. START YOUR OWN AGENCY OR WORK FOR OTHERS. LEARN ALL THE LATEST TECHNIQUES FROM THE EXPERTS.

EST. 1973 YOU ARE TAUGHT BY FORMER MILITARY INTELLIGENCE SPECIALISTS, POLICE AND PRIVATE DETECTIVES. "THE ONLY COURSE OF ITS KIND." YOUR PAST EXPERIENCE COMBINED WITH THE UNIQUE GLOBAL PROGRAM

WILL MAKE YOU A PRIVATE DETECTIVE.



"Now earning \$100,000 a year as a P.I. Thank you Global."  
A.R. Texas

CALL NOW **617-721-4292**

NO OBLIGATION • NO SALESMAN

GLOBAL SCHOOL OF INVESTIGATION  
171 S. PARK ST. STONEHAM, MA 02180

NAME \_\_\_\_\_  
ADDRESS \_\_\_\_\_  
CITY \_\_\_\_\_ STATE \_\_\_\_\_ ZIP \_\_\_\_\_  
FREE INFORMATION

# ARE YOU BEING "BUGGED?"

## OUR FINEST

# Counter-Surveillance Device

EVEN AS YOU READ THIS, countless individuals and firms are being enormously damaged by having their private conversations overheard, monitored, and/or recorded.

Almost without exception and AFTER the fact, the victims make a statement something along the lines of "But, I never thought it would happen to ME!"



## THE ULTIMATE IN "BUG" DETECTION EQUIPMENT "DEBUGS" ROOMS AND TELEPHONES!

If you require GUARANTEED PROTECTION against electronic telephone monitoring devices and also require COMPLETE CONFIDENTIAL PRIVACY in certain rooms and areas, we highly recommend the COUNTER-SURVEILLANCE DETECTOR CSD-18.



### CONDUCT A PROFESSIONAL SEARCH... ANYTIME...ANYWHERE!

Every newspaper and magazine article and every radio and TV story discussing some new episode involving "Bugging" devices, continues to increase the ever growing demand for electronic Counter-Surveillance "sweeps" and equipment. The very limited supply of competently trained and equipped Counter-Surveillance specialists has created a situation where "sweep" rates exceeding \$250 per hour are now considered reasonable and appropriate.

This is an exciting, immensely interesting and profitable field that you can enter with a minimum investment. Two hours actual practice with the CSD-18 will have you "reading" and "clearing" telephones and rooms with professional ease and competence. The average fee for "debugging" a single telephone is over \$200.00. It requires about 45 minutes to complete the job and once it gets around that YOU can provide this service, you'll quickly have more clients than you can handle. Even if you choose to provide "sweeps" for only a small number of friends and associates, your initial investment will quickly be returned many times over.

### FREE BONUS!

#### FASCINATING HI-TECH INFORMATION PACKAGE INCLUDED FREE!

##### LATEST EAVESDROPPING DEVELOPMENTS

A detailed analysis of a variety of extremely fascinating hi-tech devices and procedures used for ultra-sophisticated audio and video eavesdropping including infrared monitoring, multi-data eavesdropping and interception, miniature micro-wave devices, new methods for listening thru walls, etc., with many schematics included. You'll learn about electronic voice changers, corporate spying, how data banks are accessed to research anyone and anything, eavesdropping by neighbors; space age personnel and vehicle tracking systems, how missing persons are found, how lie detectors are deceived, and a fact-filled section on Eavesdropping Law.

##### BIG MONEY IN COUNTER-SURVEILLANCE

Complete information describing the fantastic opportunities that are now open to trained Counter-Surveillance technicians and exactly how a number of individuals and firms are reaping a huge bonanza in the booming "Debugging" business! You'll learn how the ever increasing use of Electronic Listening Devices by investigative agencies, government agencies, unscrupulous business competitors, jealous suitors, etc., has created a tremendous demand for this type of service.



A comprehensive information package JAM-PACKED FULL of some of the most exciting and fascinating reading imaginable. Reads like a James Bond novel, with one important exception...IT'S NOT FICTION!

### EXTREME SENSITIVITY!

This is our finest piece of detection equipment! The CSD-18 quickly locates electronic eavesdropping devices in telephones, homes, offices, vehicles, boats, or concealed on the body. It will actually pick up many eavesdropping transmitters at ranges exceeding 25 feet! Extreme sensitivity is obtained via ultra-efficient amplification circuitry following the RF detection stages. Excellent quality Dynamic Headphones exclude all external sounds to further enhance detector output.

The presence of any "bug" is immediately indicated via a pronounced meter deflection. The CSD-18 quickly "homes-in" on eavesdropping transmitters and immediately pinpoints their location. The closer you get to the "bug", the further the needle moves to the right. It's as simple as that.



FULL RANGE DYNAMIC HEADPHONES

### "FLASHING" LED Warns You Instantly!



And, for maximum telephone security, the CSD-18 automatically analyzes a sophisticated series of electronic measurements along the telephone line and converts the analysis into an easy to follow, step by step, test procedure. No technical knowledge is required or necessary. A visual indication (via a flashing LED) immediately reveals the presence of the various types of telephone "taps" and the flashing sequence identifies the actual type of eavesdropping device.

### MAXIMUM SECURITY — EASY OPERATION!

Latest Space-Age solid-state IC circuitry designed exclusively for maximum security and ease of operation, assures the utmost privacy protection possible today against virtually all types of room "bugs" and telephone "taps". The CSD-18 connects directly into the phone line as easily as an extension telephone and includes multi-line option for testing business telephones.



### THE ONE "BUG" TO FEAR MOST!

While most individuals are now somewhat guarded in their telephone conversations, they still rather naively feel secure in the "privacy" of their own home or office. However, the most common type of tap presently used by eavesdroppers picks up ALL SOUNDS AND CONVERSATION WITHIN A ROOM...WITH THE TELEPHONE STILL ON THE HOOK!

Due to this devastating capability, this "Infinity" tap (variously referred to as Infinity Transmitter, Hookswitch Bypass, 3rd Wire, Harmonica Bug, etc.), has become the "bug of choice".

In flagrant violation of federal law prohibiting their use and sale, these devices in various forms are openly advertised in many technical publications for as little as \$75. Literally thousands of these devices are now in the hands of unscrupulous individuals all over the country!

In response to this ever-growing threat, a uniquely engineered feature of the CSD-18 now also detects Infinity type devices anywhere "down the line".

In other words, if anyone ... ANYWHERE ... is utilizing the telephone tap and/or ring wires to monitor your private room conversations while your telephone is on the hook, you'll immediately be made aware of it via a flashing LED!

#### 100% POSITIVE INDICATION

The CSD-18 also flawlessly detects "Series" and "Parallel" telephone transmitters and "Telephone Recording Devices". And, a separate feature silently indicates when extension phones are picked up or being used. The CSD-18 completely eliminates all doubt and guesswork.

#### EXCLUSIVE "LISTEN-IN" FEATURE!

The CSD-18 will even allow you to "listen-in" to exactly what the eavesdropper is monitoring. And, without the eavesdropper ever becoming aware that he has been detected! We are unaware of ANY other detection equipment having this combined capability AT ANY PRICE!

### MAXIMUM PROTECTION

The CSD-18 provides maximum protection against ALL major categories of surveillance equipment including:

- ALL TYPES OF "CONCEALED TRANSMITTERS"
- "BUMPER BEEPERS"
- "INFINITY" DEVICES
- "BODY" TRANSMITTERS
- "TELEPHONE RECORDING DEVICES"
- "SERIES" & "PARALLEL" PHONE TRANSMITTERS

CSD-18 \$ **295** Complete

Including batteries, antenna/probe, headphones, all plugs & adapters, extensive information package and instructions.

#### HOW TO ORDER

Order NOW by Mail or Telephone. 10 DAY MONEY BACK GUARANTEE if you're not 100% pleased and completely satisfied. We pay shipping charges on all prepaid & credit card orders. Add \$15 for CODs.

(c) 1992 Great Southern Security

513 Bankhead Highway (SF)  
Carrollton, Georgia 30117

**FOR FASTEST SERVICE CALL TOLL FREE**

**ORDER BY PHONE 1 800 732-5000**



# CLASSIFIEDS

**CURRENT REQUIREMENTS** — 2.00 per word per insertion — \$40.00 minimum. All ads **MUST BE PREPAID**. Ad copy must be typed or written clearly with authorizing signature, a telephone number (for our files) and full payment. Advertisers offering information packets for a fee must send sample of packet (packets will not be returned). Name, address and telephone number are to be included in your word count. **EXAMPLE:** P.O. Box 693 = 2 words; 80306 = 1 word. Abbreviations such as DI, SGT, 20mm, U.S. count as one word each. Hyphenated words and telephone numbers are counted as two words. No personal services ads accepted. We reserve the right to refuse, delete or change any copy which we determine to be objectionable. Mail classified ads with payment to **SOLDIER OF FORTUNE**, Classified Dept., P.O. Box 693, Boulder, CO 80306.

## NOTICE TO READERS

**SOLDIER OF FORTUNE Magazine** is a magazine of national and international distribution. There may be products for which sale, possession or interstate transportation may be restricted, prohibited or subject to special licensing requirements in your state. Purchasers should consult the local law enforcement authorities in their area

**READERS OF BOTH DISPLAY AND CLASSIFIED ADVERTISING ARE ADVISED THAT SOLDIER OF FORTUNE MAGAZINE DOES NOT VERIFY VALIDITY OF EVERY ADVERTISEMENT AND/OR THE LEGALITY OF EVERY PRODUCT CONTAINED HEREIN. SHOULD ANY READER HAVE A PROBLEM WITH PRODUCTS OR SERVICES OFFERED BY AN ADVERTISER, HE SHOULD SEEK ASSISTANCE FROM HIS NEAREST POSTAL INSPECTOR AND ALSO CONTACT OUR ADVERTISING DEPARTMENT. SOLDIER OF FORTUNE DOES NOT INTEND FOR ANY PRODUCT OR SERVICE ADVERTISED TO BE USED IN ANY ILLEGAL MANNER.**

## SOLDIER OF FORTUNE DEADLINES FOR ALL CLASSIFIED ADVERTISING

'94 Issues	Deadline
May	January 21
June	February 18
July	March 18
August	April 22
September	May 20
October	June 17
November	July 22
December	August 18

**Classified Dept., P.O. Box 693  
Boulder, CO 80306-0693**

Classified ads cannot be taken over telephone.

## Russian Ladies, truly beautiful, want to meet you!

260 Beautiful, Educated Russian Ladies are sincerely seeking friendship and marriage with American men of all ages. We have selected these ladies from over 4800 applicants.

**FREE Color Photo Brochure**  
**RUSSIAN CONNECTION**

Dept. 100 • P.O. Box 888851 • Atlanta, GA 30356  
(404) 458-0909 (24 hours)  
EXCITING MOSCOW TOURS AVAILABLE

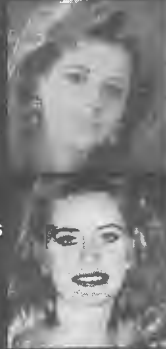

## SKELETON KEY

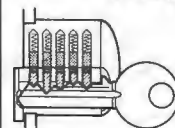

**FITS MOST LOCKS**  
(bollocks, doorlocks, & some padlocks)  
Amaze Your Friends  
With A Lock Picking Demonstration.  
You get 3 sized metal tension keys, the slide pick, precise instructions & more. Note: this device is to be used for demonstration purposes only! Satisfaction Guaranteed or Full Refund; 2 weeks delivery.

To get this exciting device, Send Now **ONLY \$8.95 + \$2 S&H** to:  
Safe Marketing • 90 W. Montgomery Av No.366SF • Rockville Md 20850

## EMERGENCY PASSPORTS

Alternate Identification

**PROTECT YOURSELF AGAINST:**

- TERRORISTS ■ HIJACKERS ■ KIDNAPPERS
- ANTI-AMERICAN ZEALOTS ■ UNSCRUPULOUS PERSONS

**"AN AMERICAN - NOT ME!"**  
TRAVEL IN SAFETY AND CONFIDENCE WITH OUR  
EMERGENCY PASSPORT AND TWO PIECES OF  
SUPPLEMENTAL I.D. ALL COMPLETELY LEGAL.  
TOTAL I.D. PACKAGE - \$125.00

## SAFEGUARD SERVICES

P.O. Box 689-F Ely, NV 89301  
(702) 289-4229

**MEN OF ACTION AND ADVENTURE** - Paladin Press has been described as "the most dangerous press in America." Millions of satisfied readers disagree. Outrageous and controversial books and videos on firearms, exotic weaponry, new identity, creative revenge, espionage and investigation, privacy, action careers, and more! To order our 56-page catalog send \$2.00 to: PALADIN PRESS, Box 1307-4AQB, Boulder, CO 80306, (303) 443-7250 (200)

**OFFICIAL SOF LOGO MAGAZINE BINDER.** Holds 12 issues, \$12.00 plus \$4.00 P&H. VISA/MC accepted. No COD's. SOF BINDER, P.O.Box 693, Boulder, CO 80306. (205)

**THE ANARCHIST COOKBOOK** is now available again! Complete, uncensored edition. Send \$25 to: BARRICADE BOOKS, PO Box 1401-Z, Secaucus, NJ 07096. (206)

## SURVEILLANCE & COUNTERSURVEILLANCE Electronic Devices

Bugging/Phone Tapping Detectors • Phone Scramblers  
Voice Changers • Telephone Recording Systems  
Caller IDs • Vehicle Tracking • Transmitter Kits • AND MORE!

**NEW!** Covert Video Surveillance Cameras and Accessories



FOR CATALOG SEND \$5.00 TO...  
PO Box 337, Buffalo, New York 14226 (716) 691-3476

## NEWMAN'S

GI SUPPLY R.D. #10, BOX 10419 - Dept. SOF  
GI NEWTON, N.J. 07860



**U.S. LARGE COMBAT FIELD PACK**  
WITH FRAME (LC 2 - ALICE PACK)

**\$118.00**  
SPECIAL

Original and current GI issue Long Range Special Mission Model has a total of 6 outside pockets. 'D' rings inside the main compartment to shorten pack if not filled to capacity. Our pack is complete with GI Frame straps, Kidney Belt, etc. Rip Stop O.D. Nylon will carry 70 lbs. easy.

Send \$3.00  
For 200 Item Catalog!  
(201)948-6200

ORDERING INSTRUCTIONS: Money Order, personal checks or Visa & MasterCard gladly accepted. NO COD's. All merchandise is 100% guaranteed. Residents of Alaska, Hawaii and Puerto Rico add 5% for shipping.

## NEW TARGETS



**Make shooting fun!**

Six military and combat style designs developed to make your shooting more fun.

**Develop a strategy —**

Choose your plan of attack. Special scoring zones put you in the action. Standard size: 10 1/2 x 12 in. Works for both handgun and rifle. 36 targets for only \$9.95 plus \$2.00 postage.

★ SEND CHECK OR MONEY ORDER TODAY ★

**RATTLER RIDGE** 236 West Portal Ave. #324-B  
San Francisco, CA 94127

Name \_\_\_\_\_  
Address \_\_\_\_\_  
City \_\_\_\_\_ State \_\_\_\_\_ Zip \_\_\_\_\_  
★ MONEY BACK GUARANTEE ★

**ENCYCLOPEDIA OF REVENGE — NOW IN SOFT COVER —**  
The Most Devastating Manual Ever Published! Over 1000 Entries. Completely Cross-Referenced. It would take 15 books to Equal the Information Jam-Packed in this Giant 8 1/2 x 11 Volume. \$19.95 plus \$3.50 Shipping/Handling to: ANCHOR PUBLISHING, P.O. Box 2630-S, Landover Hills, MD 20784. Visa/Mastercard orders call 24 hours, (800) 448-6280. Dealer Inquiries Invited. (196)

## SOLID BRASS PAPER WEIGHTS

Made from 1/2 lb of solid brass. Polished to a smooth finish

**\$12.95 Each or 2 for \$22.50**

Send check or money order plus \$4.00 Shipping & Handling to:  
Bud K World Wide MC or VISA call  
P.O. Box 565 Dept SF 1-800-543-5061  
Moultrie, GA 31776

## \$5000 Per Month...

...Deposited in your bank account just for filling out a special form that I will send to you. *Need more money? Just fill out another form. It's that simple!* Limited time only. Send \$15.00 today.

PROCUREMENT

Box 163933F Money Back  
Miami, FL 33116 Guarantee!

## APPAREL

**SPECIAL FORCES TIGERSTRIPE UNIFORMS.** 1968 Vietnam Pattern worn in "The Green Berets" NEW \$72.00, Matching Boonie Hat \$16.00. A.H.A., Box 21606, Denver, CO 80221. MasterCard & VISA Accepted! (196)

**FRENCH FOREIGN LEGION** tee shirt with Legion Motto in French and Latin! \$10.00 each. WOLFGANG, Box 709H, Prudenville, MI 48651. (196)

**CAMOUFLAGE UNIFORMS,** Soviet Coverall \$65.00, German Flektar \$80.00, French Lizard \$75.00, French Desert Camo \$75.00. Current listing from over 45 countries! \$1.00. A.H.A., Box 21606, Denver, CO 80221. (196)

**"PHUQUE U."** T-shirts. White. Blue lettering. 50% cotton. \$14.95 each. Three for \$30.00. Any size. FINEARTS, 3491, Knoxville, TN 37927. (196)

**CLINTON SUCKS-BUT HE DOESN'T INHALE** t-shirt. Send \$10.00 plus \$2.00 postage & handling to: TEXAS TEES, P.O. Box 158572, Austin, TX 78745-8572. (196)

## BOOKS & PUBLICATIONS

**BOOKS ON AFRICAN WARS,** hunting, politics. Catalogue \$2 write: Lemur Books, P O Box 1645, Alberton, 1450, SOUTH AFRICA: Fax 011-869-0890 (200)

HAT PINS - PATCHES - FLAGS

**1500+ MILITARY DESIGNS**

FREE 24 Page ILLUS. CATALOG  
WE DO CUSTOM WORK  
Dealer Inquiries Welcome

**HOOVER'S MFG. CO.**  
40155F PROGRESS BLVD.  
PERU, IL 61354  
(815) 223-1159, Ask For David

BEER MUGS AIRBORNE T-SHIRTS

**Smoky Mountain Knife Works**

The World's Largest Knife Showplace

**KNIFE CATALOG** **FREE!**

Save up to 60% on all major brands of hunting, collecting, work and survival knives. Fast efficient service and guaranteed merchandise satisfaction. Every style of knife imaginable at discount prices to you!

Visit our showroom in the Smokies, home of "The World's Largest Knife Showplace!"

**SMOKY MOUNTAIN KNIFE WORKS**  
P.O. Box 4947SF, Sevierville, TN 37864

**BEATING RETREAT (60 Minutes)**  
VHS ONLY \$39.95

By the massed bands of the Royal Marines. A spectacular rousing performance.

**BRITISH REGALIA IMPORTS**  
Department 6  
P.O. Box 50473, Nashville, TN 37205

**INTELLIGENCE GROUP SCHOOL OF INVESTIGATIONS**

**Forbidden SECRETS and Techniques of the Top C.I.'s is Here**

**KNOW THE SECRETS and TECHNIQUES USED by the TOP PRIVATE INVESTIGATORS IN THE NATION;** on Domestic, Adoption, Missing Persons, Tracking, Interrogation, Workman's Comp., and much, much more in this 473 page manual with four hours of personal and candid interviews with the experts. Learn in a few hours, how to get that confidential information from the banks, insurance companies, telephone & electric companies, trace out your adoption or find that love one, catch that cheating spouse and know where to buy the spy equipment used by the professionals. This course sells for \$795.00 through correspondence. **ORDER TODAY! LIMITED OFFER!**

**1-800-544-4779 OR 813-653-9568**  
**SEND \$199.95 plus \$10.00 S&H**  
**INTELLIGENCE GROUP SCHOOL OF INVESTIGATIONS**  
110 W. Robertson St. • Brandon, FL 33511

**TREASURE QUEST MAGAZINE.** The Journal of Lost Treasure, Shipwrecks and Recovery. Salvage, metal detecting, archaeology. Covers both land and sea treasure hunting. Subscription, 5 issues, \$16.00, 160 pages. Sample copy \$4.00. **TREASURE QUEST MAGAZINE, P.O.Box 10030, McLean, VA 22102-8030. (197)**

**SELF-RELIANCE:** food, energy, building, tools, more. Sample \$3. subscription \$17.95. **BACKWOODS HOME MAGAZINE, 1257 Siskiyou #213sof, Ashland, OR 97520. (196)**

**UNDERGROUND SOURCEBOOK** of rare devices, products and knowledge. The Underground has surfaced. FREE information, write: Box 365-U2, Penfield, NY 14526-0365. (196)

**SPY SUPPLY** **LARGEST SPY CATALOG IN THE INDUSTRY**

AMERICAN EXPRESS ACCEPTED

600 Pages of stuff too hot to handle for local stores! Unique and unusual security products, surveillance, countermeasure and micro video items. **ORDER TODAY!**

"Jesus is Lord"

**1-800-544-4779 or 813-653-9568**  
Send \$44.95 Plus \$7.00 Shipping/Handling

**SPY SUPPLY CATALOG**  
1335-F Brandon Blvd., Ste. 188, Brandon, FL 33511

**BEAUTIFUL ORIENTAL LADIES**  
DESIRE ROMANCE, CORRESPONDENCE!  
Videos available! Details, color photo brochure, send \$1.  
P.I.C., P.O. Box 461873-5F,  
Los Angeles, CA 90046  
213-650-1994



**IMPOTENCE: New Answers**

Latest research topples old taboos. New treatments over 90% successful.

**Maintain/Regain Virility**

1993 Report  
Illustrated • Lively  
Guaranteed Accurate

**MD approved**

Don't fall for quack offers. Get the scientific facts.

\$12.50 + \$3 p&h  
BioResearch • PO Box 75051F • Seattle WA 98125



**TERRORIST EQUIPMENT** and Explosive Devices, full-color pocket guide, \$8.00. 8 1/2 x 11" version, \$18.00. Laminated edition, \$32.00. AK-47, cutaway, poster \$18.00. Car Bomb Awareness poster, \$18.00. Laminated posters, \$25.00 each. **SECURESEARCH, INC., 3500 Pharmacy Avenue, Unit 4, Scarborough, Ontario, Canada M1W 2T6. (196)**

**SURVIVE CRIME, ECONOMY, famine, government, and other disasters.** Practical information. Sample newsletter \$1. **INTERESTING TIMES-SOF, Box 412, Talent, OR 97540. (196)**

**WHO KILLED KENNEDY?** Assassination research materials; Videocassettes, photographs, books, unpublished manuscripts. Catalogue: \$3.00. **COLLECTOR'S ARCHIVES, Box 2, Beaconsfield, Quebec, H9W 5T6 CANADA. (204)**

**THE POOR MAN'S JAMES BOND** \$22, The Outlaw's Bible \$15, The Anarchist Cookbook \$25, Exotic Weapons \$15, Armed Defense \$15, Privacy \$18, Underground Book Catalog \$3, Visa/MC 916-725-0341. Checks and Money Orders Accepted. **FS BOOK CO., P.O.Box 417457 Dept SF, Sacramento, CA 95841-7457. (196)**

**ALASKA COMMERCIAL FISHING.** Big money, 1 to 3 month contracts. To find out how send \$12.95 to **A&H PUBLISHING, P.O.Box 470397-S, San Francisco, CA 94147-0397. (196)**

**BUSINESS OPPORTUNITIES**

LET THE GOVERNMENT FINANCE your new or existing small business. Grants/Loans to \$500,000. Free recorded message: (707) 449-8600. (KW5) (198)

**World's Most Fascinating Police Catalog!**

112 pg. Catalog  
Badges; ID Cards;  
Books; Clothing;  
Ammo; Weapons  
Spy Equip; Posters;  
Hats & more!  
World's Best Catalog!

Send \$3.00 for Catalog, or Call 1-900-226-2444 for RUSH shipment! FREE \$3.00 Coupon included with each catalog!

**NIC, INC., Box 5950-FC, S part, LA 71135; (318) 688-1365**

**\* FREE \* TELEPHONE TRANSMITTER**

with catalog purchase. Space age micro wafer design. Line powered, never needs batteries. Long range! You tune with simple screwdriver. Ours is the best! It will out perform \$50.00 units sold elsewhere. Hightech Equipment catalog with free transmitter only

**\$10.00 (U.S. offer only)**

To: **Spy Mart**  
P.O. Box 2343-F  
Atlantic Beach, NC 28512

**REFILLABLE PEPPER SPRAY KNIFE**

6 inch steel polished blade has saw teeth and bottle opener. For refills, use any keyring size spray. Sheath has belt loop and sharpening stone. Send \$25.00 plus \$5.00 for shipping to: Davin Pilling • PO 1773 • Salt Lake City, Utah 84110



**COLLECTORS**

**VIETNAM WAR INSIGNIA AND UNIFORM LIST.** I mail a list of Vietnam War Militaria six times per year. Buyers receive a list free, others pay \$3 per list. Insignia are pictured so you know what you are buying. I always have a nice collection of original patches, insignia, books, maps, uniforms, field gear etc. Both U.S. and VC/NVA. I also buy singles and collections of Vietnam War souvenirs. 100% guarantee from me. Buy with confidence. Write or call. I always enjoy getting the straight skinny from the troops in the field. **BILL BROOKS, P.O.Box 230832, Montgomery, AL 36123. (205) 244-1916. (205)**

**MILITARY COLLECTIBLES: WWI/WWII/Korea/Vietnam.** CURRENT: Patches/Badges/Rank insignia/etc. Catalog \$3.00. CALL (408) 295-1136 or write: **LEE-JACKSON MILITARIA, P.O.Box 8663, San Jose, CA 95155-8663. (196)**

**IRAQI-VIETNAM WAR PHOTOS-COLOR.** KIA's \$10. POWs and Misc. 3 for \$10. **D.GRANT, 1440 Maryland Avenue, Spartanburg, SC 29307. 1-803-597-0273. (196)**

**BRITISH/SCOTTISH MILITARIA COLLECTORS.** Regimental insignia and accessories of elite Regiments; including SAS; Paratroopers; Royal Marines; Black Watch; Guards, etc. Import Catalog \$6.00. **BRITISH REGALIA IMPORTS, Department 6, P.O.Box 50473, Nashville, TN 37205. (196)**

**UNITED NATIONS ITEMS,** Blue Beret with Enamelled U.N. Badge \$30.00. Inspector's Baseball Cap \$20.00. Logo T-Shirt \$14.00. Patch \$4.50. **A.H.A., Box 21606, Denver, CO 80221. (196)**

**WWII RELICS!** Cheaper than certain "well-known" relics dealers! We beat their prices for flags, daggers, medals, helmets. Catalog, \$5 (refundable). Telephone: (612) 689-1146. **Militaria, Box 261-D, Cambridge, MN 55008. (197)**

**RHODESIAN AND SOUTH AFRICAN BADGES.** Medals and uniforms for sale. For a list send \$1 to **KAPLANS, Box 890638, Lyndhurst 2106 South Africa. (198)**



**FREE NAZI RELIC** with \$5.00 catalog (refund). Pre-1945 Nazi daggers, flags, medals, patches, misc. **S.C. MILITARIA, P.O.Box 104, Columbia, SC 29202-0104. (196)**

**FRENCH FOREIGN LEGION CAMOUFLAGE,** Current Issue F-1 Uniforms in "LIZARD" Pattern Camouflage, Unissued Suit 70.00, F-1 Camouflage Cap \$15.00. **A.H.A., Box 21606, Denver, CO 80221. (196)**

**EDUCATION**

**TERMPAPER ASSISTANCE.** 19,278 topics available! 306-page catalog—rush \$2.00. Research, 11322 Idaho, #205EX, Los Angeles, CA 90025. TOLL-FREE HOTLINE: 800-351-0222 (California: 310-477-8226). (200)

**Mini Stun Gun 80,000 volts**  
 The smallest stun gun on the market. ONLY 4-1/2 inches  
 This new design and technology has enabled us to produce a  
 full strength stun gun in a compact size (4-1/2 x 2-1/2 x 1").  
 The handy, small size allows you to slip it in a pocket  
 or purse easily. Comes with detachable belt clip and  
 wrist strap. Have instant protection wherever you  
 go. Purchase one for each member of your family  
 and those people you care about. Satisfaction  
 Guaranteed or Full Refund!  
 FREE Catalogue call 1 (717) 656-1604 leave msg.  
 Introductory Price:  
 Send Now ONLY \$ 39.95  
 Safe Marketing \* 90 W. Montgomery Av No.366SF \* Rockville Md 20850

**DIRECT FROM MOSCOW**  
 blondes, brunettes, redheads.  
 Lovely, earnest, eager  
 Russian girls on videotape.  
 Live interviews!  
 Find a new friend and more!  
 Tape recording: 619-450-1335.

**ISRAEL MILITARY PRODUCTS**



**AIRBORNE T-SHIRT S-XXI \$11+\$3 POST**  
 IDF WEBBING, HELMET, INSIGNIAS, UNIFORMS, T-SHIRTS  
 CATALOG \$2 (FREE WITH T-SHIRT ORDER)  
 IMP P.O.B. 31006, TEL AVIV 61310, ISRAEL

**EMPLOYMENT**

**INTERESTING CAREER LISTINGS:** Police, security, investigation. Nationwide, some international. Executives to \$119,300. Positions explained. Four monthly issues. \$21.95 PSIC/FO, P.O.Box 3831, Springfield, IL 62708. (195)

**OVERSEAS, STATESIDE.** \$100-\$1,000 daily. Now hiring. FREE list. ZINCS 117, Box 585, Dearborn, MI 48120 (196)

**FIREARMS - ACCESSORIES**

**REPLICA GUN CONVERSIONS.** How to convert the non-firing replica guns into workable and firing weapons. This booklet reveals proven method. Send \$12.95 for booklet or SASE for price list of all our products. Books, manuals, knives, and more. Send to CREATIVE CONCEPTS, 931 South Roselle Rd. Dept. 202, Schaumburg IL 60193. All BATF rules apply (196)

**NATIONAL MILITIA NEEDS YOU!** United States Special Field Forces: Government chartered, needs leaders as volunteer officers in home town. Courageous, self-reliant 18 or older. \$5 brings information and application for commission. Write: GENERAL, Box 432, Camp Bradley, FL 32066 (200)

**GUNSMITH: RON SMITH,** formerly of Western Ordnance, is one of the finest rifle "smiths" in the country for your military arms. Also, quality customizing and parkerizing. We manufacture scope mounts, muzzle brakes and other parts for most weapons. 1701 West 10th Street, #14, Tempe, AZ 85281. 1-602-964-1818. (196)

**BEAT THE GOVERNMENT GUN GRAB:** Bury a Patriot Safe! Tactical watertight vault will protect your semi-autos, etc. Sturdy PCV construction, 58" length x 8" diameter, dessicant included. \$65.00 plus \$10 S&H. MC or VISA accepted. OUTBACK MERCANTILE, Dept S, Box 33614, Northglenn, CO 80233. (196)

**FOR SALE**

**MILITARY "DOG TAGS".** 2 tags, chains, silencers. 5 lines engraving. 16 spaces per line. Send \$8.00: TAGS, P.O. Box 26942, Tempe, AZ 85285. MONEY BACK GUARANTEE. (196)

**HUNTING RETREAT,** 34 room fully equipped, semi-isolated northern forest, Alberta, Canada, river, pavement. \$200,000.00. 1-403-927-4470. (199)

**FOR SALE.** Gorgeous two story, full daylight basement. Wooded 2/3 acre. Atlanta, Georgia suburb. Intrusion despite security. Hidden entrance. Buyer needs electronic expertise. \$170,000. 404/939-0252. Early morning. Late evening. (196)

**MILITARY VEHICLES**

**SUBSCRIBE**  
 TO THE MAGAZINE THAT  
 MORE THAN 10,000 READERS  
 TURN TO FOR ARTICLES,  
 ADS & NEWS ABOUT MILITARY  
 JEEPS, TRUCKS, TANKS & MORE!  
 Full listing of upcoming rallies.

**MILITARY VEHICLES**  
 MAGAZINE

USA: 1 Year (6 Issues) \$15 • 2 Years (12 Issues) \$25  
 Canada: 1 Year \$24 • 2 Years \$44. All Others: 1 Year \$26 • 2 Years \$46  
 P.O. Box 1748-L • Union, NJ 07083  
**THE MARKETPLACE FOR MILITARY VEHICLES**

**HOMEMADE ROCKET MOTORS**  
 Make your own Commercial-Quality rocket propellants well as  
 simple sugar and fertilizer fuels. Explicit diagrams show you how  
 to make motor casings, nozzles, electric igniters, rocket  
 designs & recovery devices with a complete list  
 of suppliers. Order your book Today and  
 receive FREE Tennis Ball Cannon plans.  
 Send \$15 to:  
**AEROTEK**  
 P.O. BOX 37152, MILWAUKEE, WI 53237  
**ORDERS SHIPPED IN 48 HOURS**  
 100% MONEY BACK GUARANTEE



**COLLECTORS & SPORTSMEN...  
 AUTO KNIFE  
 BLOWOUT!**

**\$39.95** ea.  
 2 For  
**\$64.95**  
 Plus \$3 Ship/  
 Handling

**#102 NATO MILITARY**  
 3/4" Stainless  
 blade. Front opening,  
 fast lever-action.

**#104 THE GOOFATHER.**  
 Stiletto. 4" lightning-quick  
 side open stainless steel blade.  
 Lifetime Money-Back Guarantee.

Order 2 knives & get **FREE!** Swiss Army Knife  
 Check or M.O. to **PERFORMANCE KNIVES**  
 1202 Lexington Ave (Rm 192) Dept A-2, New York 10028  
 Limited offer. **ACT NOW 1-800-324-4371**

**SCHOOL OF HARD KNOCKS**  
 CUT-N-SHOOT, TEXAS

ball cap \$18.00  
 m-l-xl t-shirt \$15.00  
 xxx-xxxl t-shirt \$20.00

School of Hard Knocks  
 Box 181-SOF  
 Cut-N-Shoot TX 77303-0181  
 P-38 military can opener  
 one for \$3.00 or two for \$5.00

**FREE**

**FREE CATALOG-Military/Education Diplomas, Certificates, Awards;** any High School, University, Government Dept, New European & Corporate coat of arms. COUCH POTATO PUBLISHING, 4211 Little Rd., Suite 9, New Port Richey, FL 34655. USA. (196)

**INSTRUCTION**

**INVESTIGATION CAREER.** Quick, easy home study. 12 lessons. Become a professional. Free Information. SHAW INVESTIGATION, (Since 1971). Call (800) 272-6680. (197)

**S&S FULL AUTO CONVERSION.** No modification, alteration or deletion of original parts. Simple illustrated instructions \$10. SARDAUKAR, Box 38531-S, Germantown, TN 38138. All BATF Rules Apply. (204)

**NUDISM LIFESTYLE:  
 FAMILY RECREATION**

**Publications • Videos**



\$3 for details:  
**LIFESTYLES-SF**  
 Box 661268, Los Angeles, CA 90066

**ARREST Violators!**  
**TRAIN FAST AT HOME**  
**BE YOUR OWN BOSS!**  
**USE SECRET EQUIPMENT**

**Wear the Badge of a DETECTIVE**

**NO PREVIOUS TRAINING NEEDED**

Your spirit of adventure, danger, and self reliance can lead you to an exciting career opportunity. Solve mysteries, bring criminals to justice, protect the innocent. Experts guide you every step of the way. Men and women needed to work in challenging situations, withstanding hardships, make on the spot decisions. Learn the latest investigative techniques using special law enforcement equipment... the same equipment used by the FBI, the CIA, and the Secret Service. Start your own investigative agency. Save up to 25% and more on all equipment. Send for free details.

**Approved by Calif. Dept. of Public Instruct.**  
**THE ROUSE SCHOOL of Special Detective Training**  
 Dept. SG402 P.O. Box 25750, Santa Ana CA 92799

Name \_\_\_\_\_ Age \_\_\_\_\_  
 Address \_\_\_\_\_  
 City/State/Zip \_\_\_\_\_

**U.S. GOVERNMENT LAND**

Federally owned land currently available in AK, AZ, AR, CA, CO, ID, MT, NV, NM, OR, UT, WA, WY for **\$2.50 per acre.** U.S. citizens entitled to purchase **up to 160 acres per person.** For complete information package including maps, telephone helpline, filing forms, etc. send \$20 check or money order to: **FEDERAL LAND CO., Dept L, Box 21598, Washington, DC 20009.** (Note: this is not homesteading—lands are sold outright.) **MONEYBACK GUARANTEE!**

**Become a gun repair expert!**

Professional-level home study trains you to do expert work on all kinds of firearms. Call today for free literature: **800-223-4542.**

Name \_\_\_\_\_ Age \_\_\_\_\_  
 Address \_\_\_\_\_ Phone (\_\_\_\_) \_\_\_\_\_  
 City \_\_\_\_\_ State \_\_\_\_\_ Zip \_\_\_\_\_

**School of Gunsmithing, Dept GB171**  
 6065 Roswell Rd., Atlanta, Georgia 30328



**KNIVES - BAYONETS**

**NAVY SEAL diver's/combat knife.** \$44.95 plus \$5.00 shipping. Money back guarantee. WORKMAN'S, Dept SOF, Box 312, Edinburg, PA 16116. (196)

**SWITCHBLADES:** The real thing! Powerful spring action. High quality. Made in Italy. Many designs discounted. 100+ page catalog of switchblades/exotic knives \$3.00 APEX ORDANCE, P.O.Box 363, Batavia, NY 14021. (xxx)

**MISCELLANEOUS**

**BIG BROTHER KNOWS YOUR LIFE STORY.** Order your FBI, CIA, IRS, DoD, NSA, State records, more. \$35. Send full name, birthdate/place, SSN: INFORMEDIA, Suite 376F, 2020 Pennsylvania Ave., N.W., Washington, DC 20006. (197)

**MARTIAL ART EQUIPMENT,** stun guns, cross bow, and hundreds of other exotic weapons at low low prices. Send \$1.00 for our special sale catalog. SEN-OJ, Box 25058, St. Louis, MO 63125. (196)



## BAD GUY/HOSTAGE Practice Targets!!!

17"x 20" Head To Scale  
100 Targets - \$29.95  
50 Targets - \$19.95

SEND CHECK OR MONEY ORDER TO:  
P&S ENTERPRISES  
PO Box 1206, Paradise, CA 95967-1206  
Add \$2.50 for S&H • Owner is Member of NRA



## Color Vinyl Bumper Stickers

Maybe Clinton never inhaled,  
But as president, he sure does SUCK!

Bill Clinton  
for  
Change



When Clinton says he has a new plan for America, just say  
**BOHICA!**  
Bend Over, Here It Comes Again!

If Bill Clinton is the answer,  
Somebody asked a really stupid question!

\$3.00 each - 2 for \$5.00

PJP, 9800-D Topanga Canyon #161, Chatsworth, CA 91311

## UNUSUAL BOOKS

MANY AVAILABLE NOWHERE ELSE  
100's of Titles to Choose!

CREDIT • EMPLOYMENT • EXOTIC WEAPONRY • MARTIAL  
ARTS • PRIVACY • NEW IDENTITY • DISGUISES  
• SURVEILLANCE • FIREWORKS and Much, Much More!  
Best Prices and Selection. Money Back Guarantee.

Catalog .....\$1.00

ALPHA PUBLICATIONS

PO Box 308-M Sharon Center, OH 44274

## Genuine RAMBO® Knives

Each only  
**\$88.50**  
plus \$4  
shipping &  
handling



The only LICENSED reproductions. Each blade is 1/4" thick. Rambo I & II have hollow handles complete with survival kits, liquid filled compass on inside of butt cap, saw teeth (that really work) on backside of blade and bladeguards that feature phillips head and standard screwdriver points on each end.

Rambo I measures 14" with a 9" blade.

Rambo II measures 15 3/8" with a 10" blade.

Rambo III measures 16" and features full-tang construction and an anti-glare sighting slot in its 11" blade. The superior design of its hardwood handle fits beautifully in your hand. Each comes with a top-grain leather sheath and a full-color gift box. Money-back if not completely delighted. Send check or money order to:

SPOTLIGHT SPORTS CO.

P.O. Box 1050

Saugus, MA 01906

COMBAT TOPOGRAPHIC MAPS. Tactical, Quads, and Travel Maps. (Europe, Vietnam, Texas, ANYPLACE). Amazing catalog \$3.00 (refundable). MONARCH, P.O. Box 42003-A203, Phoenix, AZ 85080. (196)

MALE POWER PACK. Creates/builds muscle, strength, stamina, endurance. Can elevate testosterone level 200%! Enhances virility. Safe. ON SALE: 1-800-878-8844. (196)

TOBACCO: SWEET CHEWING. Moist/Dry Snuff, Pipe/Cigarette Smoking, Twist/Plugs. Catalog \$1.00. USA ORDERS ONLY. FRED STOKER & SONS, INC., P.O. Box 707-SOF, Dresden, TN 38225-0707. (196)

VANISH FROM POLICE RADAR! Legal Jammers defeat radar and laser speed guns. Cop sees "00" true stealth has arrived! Brochure: JAMMERS, INC. 800-451-4477. (196)

## TELEPHONE LISTENING DEVICE



Set 1cu. in.

Record telephone conversations in your office or home. Connects between any cassette or tape recorder and your telephone line. Starts automatically when phone is answered. Records both sides of conversation. Stops recorder when phone is hung up.

**\$19.95** EACH Qty. Disc. Avail.



## Super Powerful FM TRANSMITTER

Many times more powerful than other transmitters. Transmits up to 1/4 mile to any FM radio - Easy to Assemble Kit - up to 9V battery (not incl.)

For catalog of Transmitters, Voice Scramblers and other specialty items, enclose \$2.00 to USI Corp

Call 407-725-1000 or send \$18.95 + \$1.00

shipping per item to: USI Corp, P.O. Box

SF-2052, Melbourne, FL 32902 COD's OK

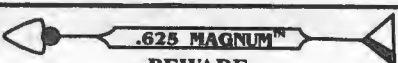

**.625 MAGNUM™**

**-BEWARE-**

The World's Most Powerful Blowguns are DOWN & DIRTY!

Write or Call For Immediate Info.

J.W. McFARLIN COMPANY

P.O. Box 209, Lake Havasu City, AZ 86405-0209

Tel. (602) 855-8095

## SEXY GIRLS - GUNS CALENDAR

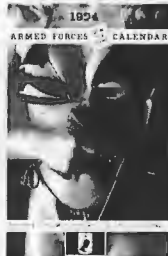

1994

1994

\$9.95 +  
\$1.95 S&H  
(OH res. +  
.65 tax)

BULLDOG PRESS OF OHIO  
6784 Manchester Rd. Dept. F  
Middletown, OH 45042

## REGIMENTAL INSIGNIA & WEAPONRY

• SAS • AAF • BLACK WATCH  
• PARA • AM • CAMERONS  
• ASDG • RN • GUARDS etc.

Import Catalog \$6.00

BRITISH REGALIA IMPORTS

Department-6

P.O. Box 50473 • Nashville, TN 37205

NEW IDENTITY! Everything included to completely change identity. Driver's license, Social Security, Birth Certificate, Identification Card, Complete Instruction Booklet. Send \$29.95 to "CAS", P.O. Box 2392, Redondo Beach, CA 90278. (196)

KNIGHTS OF THE MOST NOBLE Order of the Tower, military knights of charity. Free Information. THE GRANDMASTER, Chancery Office, 3310 Tyrone, El Paso, TX 79925. (196)

SECRET SCANNER. Frequencies! Federal Agencies, Police, Surveillance, etc. Big Free Catalog! CRB, P.O. Box 56-F, Commack, NY 11725. Phone (516) 543-9169. (198)

SEEKING HARMONIOUS RELATIONSHIP? Meet beautiful educated ladies local & worldwide for friendship/marriage. 600 photos brochure. Send US\$5.00. EAST-WEST, Box 814, Tolland, CT 06084. Limited Issue. (196)

BEAUTIFUL MEXICAN WOMEN seek romance! Free photos, full information. LATINOS, Box 1716(TN), Chula Vista, CA 91912. (619) 685-5195. (196)

MEET WOMEN WORLD WIDE Free 32 page photo catalog. America's most respected correspondence club since 1974. CHERRY BLOSSOMS, 190FT Rainbow Ridge, Kapaau, HI 96755 (408) 980-7488 (200)

ASIAN WOMEN DESIRE CORRESPONDENCE! Overseas, sincere, attractive, traditional. Free details! SUNSHINE INTERNATIONAL CORRESPONDENCE, Box 5500-ZH, Kailua-Kona, Hawaii 96745 (808) 325-7707 (198)

R & R FOR SINGLE MEN. Enjoy a playful vacation in the Philippines and meet exotic dreamgirls. Big Apple Oriental Tours (SOF), 249-12 Elkmont Ave., Bellerose, NY 11426 (196)



## BUSHPILOT WINGS

BADGE QUALITY - CORROSION FREE RHODIUM

SEND \$6.95 TO: BUSHPILOT

P.O. Box 541384

DALLAS, TX 75354-1384

CATALOG WITH PURCHASE - ALLOW 4-6 WEEKS

## Men & Women! Be A ...

## PRIVATE EYE



Amazing one-of-a-kind home study course tells all! Want a life of intrigue, excitement, adventure?! Quickly learn from the experts:

- How To Earn \$100,000 A Year As Your Own Boss!
- How To Conduct All Types Of Private Investigations, Skiptracing & Surveillance!
- How To Start Your Own Private Detective Agency!
- How To Work From Home, Part-Time or Full-Time!
- No Experience Necessary, No Investment Required!

STATE APPROVED

Located in the Entertainment Capitol  
Of the World! (213) 879-1165

FREE  
DETAILS

UNITED STATES ACADEMY  
OF PRIVATE INVESTIGATION  
P.O. BOX 2133 (SF)  
BEVERLY HILLS, CA 90213

## U.S. MILITARY INSIGNIA

1940 through Current

Large Catalog, \$3.00

SAUNDERS

Box 3133 • SF • Naples, FL 33939-3133



INTELLECTUAL WORLDWIDE LADIES. Accurate names, addresses, descriptions: Indonesia, S.America, Norway, Russia, Philippines, New Zealand, Poland, Malaysia, Taiwan, Hong Kong. Each group 50 addresses US\$15. HUISU, Box 582, Tolland, CT 06084. (196)

MEET THAI, ASIAN, WORLDWIDE, LADIES! desiring romance, lifemates, through correspondence. 275 photo catalog. Your personal ads placed in over 40 countries. FREE Brochure: TAWL, P.O. Box 937(SOF), Kailua-Kona, HI 96745 (808) 329-5559 (196)

PHOTO I.D. CARD (50 states). Send photo, eye/hair color, height, weight, birthdate. \$15.00. MAXSELL, P.O. Box 23021, Ft. Lauderdale, FL 33307. (197)

TEENAGE ASIAN GIRLS desire men over 40! Marriages! 250 girl video \$17.95. TOURS ROYALE, Box 957, Deerfield Beach, FL 33443-0957 (196)

LOST DOCUMENTS REPLACED. College Degree, High School Diploma, Birth, Baptismal, Marriage, Divorce, Discharge Etc. SASE to MAXSELL, P.O. Box 23021, Ft. Laud. FL 33307 (198)

BEAUTIFUL RUSSIAN WOMEN! through overseas correspondence eager, sincere and faithful! FREE 32 page - 500 photo catalogue. CLUB PRIMA, 13164 Memorial Drive, #233DD, Houston, Texas 77079. (713) 973-1515 anytime. (203)

LOVELY LATIN LADIES seek friendship, marriage! Free photo brochure. WORLD, Box 7358(TN), Moreno Valley, CA 92552. (619) 521-2833. (196)

BEAUTIFUL, TRADITIONAL, ROMANTIC Asian ladies desire friendship and marriage. Free photo catalog. ASIAN CONNECTIONS, Box 1230, LaGrange, TX 78945. (409) 242-5820. (196)

ADVENTURE IN PARADISE! Beautiful South Pacific Islands can be acquired for as little as \$200.00. For info write or call PACIFIC ISLANDS CONSULTING, P.O. Box 1010, Dept. B, Blue Jay, CA 92317. 1-800-854-0866 (198)

RUSSIAN LADIES, truly beautiful, educated, want to meet YOU. Free color photobrochure. Russia46, P.O. B. 888851, Atlanta, GA 30356, (404) 458-0909, Anytime. (203)

**PISTOL CROSSBOW**

- Very Powerful • Portable
- Pinpoint Accuracy
- Outstanding Performance



Features: Diecast Gun Body, Polyester String, Adjustable Sights (wind, elev) Suspension Steel Bow, 5 Aluminum Tipped Bolts, EZ-Hand Cocker target included and 4SLB draw  
Spare String \$5.00; Spare Bolts (10 pack) @ \$7.00  
S.R. BARCLAY, P.O. Box 370024, Denver, Colo. 80237

**\$34.95 or 2/\$31.95 Ea.**  
Ck/MO plus \$5.00  
S/H Guaranteed

**SPY SHOPS OF AMERICA**

**Super Powerful FM Transmitter Kit**



**FM Transmitter Inside Common Dual Modular Telephone Adapter.** Has up to 1/4 mile range. New EZ Snap Fit Kit. Super Powerful, Tunes 88-108 Mhz. Can be picked up Crystal Clear on an FM Radio. Transmits both sides of the Conversation. Uses Phone Line for Power and Antenna.

**ORDER NOW! Limited Offer!**

**SEND \$99.95 PLUS \$5.00 Shipping & Handling**  
MO, Check, or Am. Ex. (No COD's)  
TO  
**SPY SHOPS OF AMERICA**  
1335-F BRANDON (813) 684-8081  
BLVD., STE. 190, - Today & Tomorrow Jesus  
BRANDON, FL 33511 Reigns -

**YOUR MILITARY MEDALS!**



**LARGEST INVENTORY IN THE U.S.A.!**

- FULL SIZE US MEDALS
- UN AND RVN MEDALS
- MINIATURE MEDALS
- OFFICAL RIBBONS
- RANK BADGES . PATCHES... ALL GUARANTEED!
- SKILL BADGES
- DISPLAY CASES
- MANUALS ON CLAIMING MEDALS

**SEND \$2.00 TODAY FOR ALL NEW COLOR CATALOG!**

**MEDALS OF AMERICA**  
1929S2 FAIRVIEW ROAD  
FOUNTAIN INN, S.C. 29644

**BE A PARALEGAL!**

Attorney-instructed home study prepares you for an exciting future in America's hottest career. Free booklet: 800-223-4542.

Name \_\_\_\_\_ Age \_\_\_\_\_  
Address \_\_\_\_\_  
City \_\_\_\_\_ State \_\_\_\_\_ Zip \_\_\_\_\_

The School of Paralegal Studies, Dept. LB171  
6065 Roswell Road, Atlanta, Georgia 30328

**FREEDOM COUNTRY**



20 BIG acres in WESTERN MONTANA, starting at \$9850. Trout fishing, backpacking, camping, Elk, deer, moose, bear. ADJACENT to National Forest, near established towns, Yellowstone and Glacier National Parks nearby. GUARANTEED ACCESS, INSURED TITLE, WARRANTY DEED. FREE color brochure, photos, maps.

**FULL MONEY-BACK GUARANTEE**  
"Video Available"  
**CALL TOLL FREE 1-800-582-5990**  
**TREASURE STATE RANCHES**  
210 Milwaukee Street, Dept. S  
Deer Lodge, Montana 59722 — (406) 846-1000

Is there a limit to political incorrectness? If so, you won't find it in **The Radar Jammer's Cook Book!** One third of all radar-based speeding tickets are wrong! Counterattack with all the tricks: threat detection, X-, K- and Ka-band jamming, radio jamming, convoy jamming, chaff, high-speed evasion, "stealth", passive/active measures to beat photo radar, plus ways to detect & jam LASER SPEED-GUNS! Profusely illustrated, sprawling 8.5x11 format. \$33 domestic PPD. Registry Distributing, 200 Union Blvd., Suite 430, Denver, CO, 80228.

**SOLD ONLY TO ENTERTAIN!**

**The Radar Jammer's Cook Book**

Electronic Warfare on the Highway  
Peter Diamond

**BE A PROFESSIONAL SKIPTRACER & MISSING PERSON INVESTIGATOR!**

**AMERICA'S FASTEST GROWING INVESTIGATION INDUSTRY!** LEARN SKIPTRACING & MISSING PERSON INVESTIGATIONS. ATC'S IS THE NUMBER ONE PROFESSIONAL TRAINING PROGRAM; PROFESSIONAL TECHNIQUE TO TRACKDOWN FUGITIVES, SKIPPERS & MISSING PERSONS. THIS EXCLUSIVE PROGRAM HAS BEEN DESCRIBED BY PROFESSIONAL BOUNTY HUNTERS AS THE "1-2-3 HIDEOUT BUSTER". OVER 550 PAGES (17 PROF. BOOKS) - INCLUDES COMPLETE US & CANADA SEARCH REFERENCES (800 PRIVATE & PUBLIC INFO. SOURCES), CHARTS, CHECKLISTS, ONLINE DATABASES, THE BEST TRAINING PROGRAM ALL AROUND!

DZ'S OF EXCLUSIVE INVESTIGATION FEATURES. STUDY TODAY, START TOMORROW! \$50-\$100,000 YEAR!!! START WITH MINIMAL INVESTMENT. PROGRAM COMES WITH "FASTRACK GUIDE TO SUCCESSFUL SKIPTRACING" FORMSETS AND MORE!!! TREMENDOUS OPPORTUNITIES TODAY "IN THIS FIELD OF THE FUTURE"!!!

**SEND \$2.00 FOR 16 PAGES INFOPACK!**

**ATC: PROFESSIONAL TRAINING IN TRACKING DOWN FUGITIVES!**

**American Tracing Corp.**  
289 College Street, Burlington, VT 05401-8320

**THE P.I. - SPY & SECURITY SOLUTIONS CATALOG**

Hard to find books, manuals, videos, directories, sources of information, equipment, computer products, I.D. cards, badges, security, self defense, investigative, countermeasures, surveillance and police equipment. World's largest. 40 page catalog. Send \$2.00 to Thomas Publications, P.O. Box 33244-SF, Austin, Texas, 78764. **World's Largest**

**Need NEW ID? CREDIT • PRIVACY**

OUR BOOKS HELP YOU GET: New Identity & credit.

- Jobs in 48 hours. College degrees. ID by mail.
- Cash income. Private loans. Asset protection.
- Offshore banking. Foreign passports & MORE!

**FREE 40 pg. PRIVACY CATALOG: 800-338-8484**  
EDEN PRESS • Box 8410-PS • Fountain Valley, CA 92728

**HOW TO ROB BANKS LEGALLY!** Make \$9,000 per bank account opened. Complete package send \$24.95; PROCUREMENT, Box 9522, Coral Springs, FL 33075. (196)

**PASSPORT ESTABLISHES 2ND IDENTITY** For International Safe Travel. Entry and Exit Stamps. Ultimate Identification Worldwide. Legal U.S. Customs. 3 Backup Photo I.D.s Complete \$400. (305) 568-1480 (24hrs). (197)

**STUN GUNS!** 120,000 Volts! Only \$49.95 ea. BENTHAM INTERNATIONAL, Dept SF, 4291 NW 18th St., P-104, Lauderdale, FL 33313. (196)

**WHAT DOES BIG BROTHER KNOW ABOUT YOU?** Your FBI, CIA, IRS records and more. \$49.95 + \$6 shipping. Send name, SSN, birthdate & place: BLUETREE, Box 4177FN, Mountainview, CA 94040. (196)

**VIDEOS! CLOSEOUT PRICES.** Free Catalog. State age of 21. ESD, P.O. Box 5571-sof, Gainesville, FL 32602. (196)

**REMAILING SERVICES**

CONFIDENTIAL ADDRESS. Mail received here, then forwarded to you worldwide. Volcemail, tool MAILPOST, 2421SOF Pratt, Chicago, IL 60645 (312) 764-0100. (800) 890-3199 (196)

**SECURITY PRODUCTS**

CONFIDENTIAL Catalog of Police and Investigation Equipment \$2. IPEC, Department SF893, P.O.Box 7638, Moreno, CA 92552. (197)

**SURPLUS**

MILITARY CLOTHING, GEAR, Boots, Jackets, Collectibles, etc. Call (408) 295-1136 for FREE catalog or write: LEE-JACKSON MILITARIA, P.O.Box 8663, San Jose, CA 95155. Foreign catalogs are \$3.00. (196)

**SURVEILLANCE**

**SHERWOOD - The first name in surveillance equipment.** Complete line of investigative, communications & countermeasures equipment. **CONTACT THE SURVEILLANCE SPECIALISTS**

SHERWOOD COMMUNICATIONS ASSOCIATES, LTD.  
PO Box 5358, Southampton, PA 18966  
(215) 357-9065

**NOT FREE-BUT CLOSE!** Camping, Boats, Tents, Military Surplus, Books, Karate, Survival, Knives, Swords, Blowguns, Backpacks. Catalog \$2.00(refundable); GENERAL LOGAN PX STORE, 3222 South Logan, Suite 30F, Lansing, MI 48910. (197)

**MILITARY SURPLUS & SURVIVAL ITEMS:** Large Inventory, new and used. Mail \$1. (refundable) for price list: HUGH WADE'S, 2120 West Reelfoot Ave., Union City, TN 38261-9732. (196)

**FREE CATALOG!** Army-Navy Surplus, Survival Gear, Disaster Preparedness Supplies. HAYDEN TRADIN' COMPANY, P.O.Box 1666, Hayden, ID 83835. (800)845-6590. (195)

**SOLAR WATCH** with free magnetic compass. Send \$2.00 to INTELECTRON, Dept 259F, 2023 N. Atlantic Avenue, Cocoa Beach, FL 32931. (196)

**GOVERNMENT SEIZED Security Equipment, Tents, Cars, Trucks, Boats.** Surplus Bargains Galore! Your Area. Toll Free Information: 1-800-601-2212, Ex.SP7770. (197)

**Get Your Own Military Style ROCKET LAUNCHER**

Collectors Item!



**Out they Go!**  
**\$39.95**  
30 day Money Back Guarantee!

Voted One of the Best New Products For 1992 and Featured in American Survival Guide and Machine Gun News!

**The XK-1A puts power at your fingertips!**

Designed after the LAW Rocket Launcher used by the US Military, the XK-1A features a two-stage electronic ignition system that fires rockets over 500 feet at an incredible 100 m.p.h.! Legal-XK-1A-Length 35"-Rocket 12" Safty Sheild- Weight 6Lbs

**Special Bonus!**

Order today and receive our Exclusive simulated "Lock On" target sound system. A \$15.00 value absolutely FREE! No Dealers please. Rock bottom prices! Send \$2.00 for information.

**ORDER NOW!**  
XK-1A Launcher \$39.95 • FX-2A Reusable Rocket \$12.95, 2 for \$19.95 + \$9.00 S/H  
Cheque or Money Order (US Funds) To:  
**OLEN INDUSTRIES**  
#478-21-10405 Jasper Avenue  
Edmonton, Alberta, Canada T5J 3S2

**SURVIVAL**

**SMOKE BALLS, CARTRIDGES, Candles, Bams, Pots, Grenades.** Largest selection anywhere. Write for 56-page catalogue of 500 products. U.S.-\$3.00, Canada-\$5.00, Others-\$10.00. SIGNUS, Box 33712-W48, Phoenix, AZ 85067 (196)

**ENVIRONMENTALLY SAFE Refrigerator.** Requires no moving parts or electricity. Send \$5.00 for plans. MD INDUSTRIES, P.O.Box 109, Youngstown, FL 32466. (196)

**WANTED:** Bushwackers, Revolutionaries, Pirates, Bounty Hunters, Soldiers, Men who are TRULY TOUGH! you NEED our book catalog! Mail \$1.00 to: GADDIS PUBLICATIONS, P.O.Box 411476-SOF, Los Angeles, CA 90041. (199)

**TRAINING**

**RANGER, AIRBORNE, Bodyguard Training.** Catalog and information \$7.00 (\$12.00 Foreign). USTC, 2024 N. Broadway, Suite 205, Santa Ana, CA 92706-2623. (714) 547-2567. (199)

## ADVERTISERS INDEX

Automatic Knife Resource Guide	67
B-Square	71
Bagmaster	Cover 3
Behind The Lines	66
Collector's Armoury	64
Danner Shoe Mfg	19
Doubleday Military	9
Excalibur Enterprises	10
Executive Protection	25
Fighting Firearms	70
Fighting Knives Magazine	66
Great Southern Security	76
High Caliber	21
Knights Manufacturing Co.	Cover 4 & 65
MBI	17
Machine Gun News	70
Michigan Body Armor	65
Miniature Machine Corp	70
National ID Center	16
Optimum Training Systems	11-14
Orpheus	67
P.F.S. Video Inc.	8
Paladin Press	7
Quality Machining Inc.	67
Reitz Industries	26
S&K Products	21
S.T.A.N.O.	18
SOF Soundscope	69
Sonic Technology, Inc.	28
Soque River Knives	26
Southern Ordnance	27
Starlight Imaging Systems	68
Steve Arnold's Gunroom	Cover 2

### SUPPLY LOCKER

Auto-Ordnance Corp.	72
Cutlery Shoppe	73
David Steele Ent. Inc.	73
Eden Press	73
Facets Advertising	72
Global School of Investigation	75
Greene Military Dist	72
Gun Parts Corp.	75
Hitek International	74
JTR Labs	74
Lile Handmade Knives	72
LA Law Enforcers	74
MIW Design	75
M.O.R.O. International	72
Matthews Police Supply	73
Motion Graphics	74
National ID Center	75
North American Integrated	75
S & K Performance Products	72
SSK Industries	73
Safety Technology	74
Shogunite Corp.	75
Silvermans	73
U.S. Cavalry Inc.	72
USI Corporation	75
WW2 Products	74
Westbury Sales	74

ADVERTISING POLICY: Publication of any advertisement in Soldier of Fortune Magazine is not an endorsement of the advertiser of the product(s) or service(s) advertised, either by SOF Magazine or by the Editor and Publisher.

## CHIMOIO

Continued from page 71

Unfortunately, Rhodesia's politicians were not as adept as its armed forces. Losing their battle at a negotiating table in London, Rhodesia fell two years later, after a protracted war during which its military had lost not a single firefight.

*A veteran of Rhodesian SAS, U.S. Army, South African and Transkei defense forces, Maj. Robert MacKenzie is SOF Contributing Editor for unconventional operations.*

### LENGTHENING THE REACH

Ninety percent of SAS operations in the Rhodesian war were conducted in either Zambia or Mozambique. Many of these ops were so far from Rhodesian bases that intermediate staging areas had to be set up well inside hostile countries. These staging areas were called "admin bases."

Sites were usually 20 to 30 kilometers from the intended target. In a deserted part of the countryside, the sites were preferably in low bush or elephant grass, without big trees, and near water when possible.

Once a site had been selected, the base would be established at H-hour, concurrent with the attack. SAS headquarters personnel, sometimes bolstered by RLI paratroopers, would jump in and start clearing enough trees for up to 15 Alouettes. Each chopper carried its own portable fuel pump. Reserve ammunition, both for helicopter gunships and ground troops, would also be dropped in, and sometimes a regimental aid post would be set up. If the site had no water, common in the dry season, that would also be dropped.

While the base was being established, other troops would patrol and secure the area against enemy interference. All too soon the first wave of G-cars would arrive for refueling, having delivered their troops to their assault positions. These helicopters would stand by in the admin base until called back for casevacs, resupply, or redeployment of ground troops. There would also be constant arrivals and departures of gunships as they rotated over the enemy camp and came back for refueling and rearming. Often eight to 12 helicopters would be on the ground at any one time.

The admin base stayed open dur-

ing the course of the battle and, when it was over, served as a reception area for withdrawing troops. Given the limited lift and range of her helicopters, the "admin base" concept proved to be essential for the spectacular success of Rhodesia's deep penetration raids.

— R. M. ✕

## JUST CAUSE

Continued from page 43

It was his earlier defense of Beam against a charge of seditious conspiracy that brought Lyons recognition as a skilled attorney — and notoriety as a defender of right-wing extremists like Beam, whom the attorney calls "dissidents." "I'm a Don Quixote," Lyons said. "I believe one should fight for principle."

Conspiracy — the keystone of our federal government's case against 11 Branch Davidians scheduled for a January trial in San Antonio — "is the favorite law enforcement tool of the government," Lyons observed. "I consider it an unconstitutional evil, a good way to get in a lot of hearsay testimony. As part of our criminal-justice law enforcement program, I think it is a nightmare. It is like Stalinist thought crime. This type of so-called justice is our enemy, and if they pick on the Klan or Tom Metzger or the Center for Democratic Renewal or the Socialist Workers Party, it is the same.

"The greatest threat to liberty in the world today," Lyons continued, "is the American government ... bar none ... So that means we're going to be defending people who are not in the mainstream, that are not popular, that are not even likable ... But if they do not have rights ... to a fair trial, then nobody else does.

"I'm a sucker for the underdogs. I might not believe what they believe, but I believe in their right to believe it. As long as they're persecuted for their beliefs, somebody needs to stick up for them. Otherwise, sooner or later, it will be us."

CAUSE Foundation needs your financial support to help maintain their vital work in the Waco case. Send your donations — these are not tax deductible — to: CAUSE Foundation, Waco Defense Fund, P.O. Box 1235, Black Mountain, N.C. 28711. ✕



**American Made & Guaranteed For Life! 100% Money Back Guarantee**  
**BAGMASTER MFG., INC.**  
 2731 Sutton Ave., St. Louis, MO 63143 • 1-314-781-8002 • FAX 314-781-3363  
 To Order, Call Toll-Free 1-800-950-8181 Dept. SOF



**Cordura® Nylon Hook & Loop Fanny Pack**  
 With Padded, Breakaway Pistol Pocket.

**3 Sizes to Choose From**

- Model #HLFP-S \$21.95**  
25 & 380 Auto  
2 1/2" Revolver
  - Model #HLFP-M \$24.95**  
9mm & 45 Auto w/4" Barrel & 3" Revolvers
  - Model #HLFP-L \$25.95**  
9mm & 45 Auto w/5 1/2" & 4" Revolvers
- Colors: Black or Blue



**Cordura® Nylon Rectangular Pistol Pouches**

Model	Sizes	
REC-8	6" T x 8" L	\$14.95
REC-9	7 1/2" T x 9" L	\$18.95
REC-13	9 1/2" T x 13" L	\$21.95
REC-18	9 1/2" T x 18" L	\$27.95
REC-24	9 1/2" T x 24" L	\$33.95

All Sizes Have An Outside Pocket And Inside Pockets. REC-9 Pictured Above.  
 REC-8, -9, -13 Black or Blue  
 REC-18, -24 Black Only

**Cordura® Nylon Zippered Fanny/Belt Pack**  
 With Hideaway Padded Pistol Pocket  
 Works Right and/or Left Hand



**Model #ZFBP-S** - Size: 6" T x 7 1/2" W x 1" Deep. Holds Most All 22, 25, 32 & 380 Autos and Snub Nose Revolvers with Up to 2 1/2" Barrel. **\$17.95**  
 Colors: Black or Blue

**Model #ZFBP-L** - Size: 7" T x 9" W x 1" Deep. Holds Most All Med. and Large Frame Autos with Up to 5 1/2" Barrel and All Frame Size Revolvers with Up to 3" Barrel. Colors: Black or Blue **\$19.95**

**Cordura® Nylon Belt Pistol Pack**  
 Works Right and/or Left Hand



**Model #BPP-S** - Size: 5 1/2" T x 4 1/4" W x 2" Deep. Holds Most All 22, 25, 32 & 380 Autos. Colors: Black or Blue **\$15.95**

**Model #BPP-L** - Size: 8" T x 5 1/4" W x 2" Deep. Holds Revolvers with Up to 3" Barrel and Medium and Large Frame Autos with Up to 4" Barrel. Colors: Black or Blue **\$18.95**

**Model #BPP-XL** - Holds Revolvers with Up to 4" Barrel and Medium and Large Frame Autos with Up to 5 1/2" Barrel. Color: Black or Blue **\$19.95**

**Cordura® Nylon Holsters**  
**\$17.95 Each**

When Ordering Please Specify: Make, Model and Barrel Length



**Belt Holster With Magazine Pouch**  
**Model #BHMP**

All holsters come w/thumb break



**Clip Holster With Magazine Pouch**  
**Model #CHMP**

All holsters come w/thumb break



**Cordura® Nylon Extra Large Pro-Shooters Bag**  
**\$139.95 Model #PSB-XL**

*Description: (Pictured above)*

- Main Compartment - 11 1/2" T x 8" W x 20" L. Fully Padded and Lined with Hardboard Bottom.
- 4" Wide Double Zipper Top for Easy Access to Main Compartment.
- Two Padded Dividers 9 1/2" T x 10" W, with Hook-and-Loop Fasteners, Allow You to Make Three Separate Compartments.
- Large Outside Pockets - Two at 10 1/2" T x 3" W x 19" L. Fully Padded and Lined.
- Flat End Pockets - Two at 9 1/2" T x 8" W. Fully Padded and Lined.
- Large Pistol Pouch Fits in Large Outside Pocket - Two at 9" T x 18 3/4" L. Foam Padding and Plush Nylon Tricot Lining. 1 1/2" Web Strap with Hook-and-Loop Fasteners Secures Guns with Up to 10 1/2" Barrel with or without Scope.
- Small Pistol Pouch Fits in Large Outside Pocket - Four at 9" T x 8 1/2" L. 3/4" Foam Padding and Plush Nylon Tricot Lining. 1 1/2" Web Strap with Hook-and-Loop Fasteners Secures All Frame Sizes of Revolvers with Up to 4" Barrel and All Medium and Large Frame Autos. Each Pouch Has Six Padded Magazine Pockets on Outside of Pouch.
- Four D-Rings
- 2" Removable and Adjustable Padded Shoulder Strap
- 2" One-Piece Wraparound Handles
- Colors: Black or Blue



(Padded Pistol Pockets)



**Cordura® Nylon Small Pro-Shooters Bag**  
**\$45.95 Model #PSB-S**

Holds 2 Guns and Plenty of Gear For a Day at the Range. Hardboard Bottom. Bag Size: 7 1/2" T x 7" W x 16" L. Colors: Black or Blue

**New & Redesigned Cordura® Nylon Large Pro-Shooters Bag**  
**\$94.95 Model #PSB-L**

Main Compartment: 10" T x 7" W x 18" L. Fully Padded & Lined with Two Padded Dividers. Four Padded Pistol Pouches Fit in Padded, Outside Full-Length Pockets. Colors: Black or Blue Same Style as PSB-XL

For Information or Free 44 Page Catalog, Call 1-314-781-8002 FAX 314-781-3363 We accept: VISA, MasterCard, AmExpress; Shipping & Handling 1st 48 States - \$5.00 Per Order\*. C.O.D. Orders Add \$4.50. Next Day & Second Day Air Freight Available Upon Request, \*Alaska & Hawaii Higher. For European orders and catalogs call 011-34-32-80-21-29. For orders or a catalog in Australia call 011-61-47-59-15-71.



**NO POSTAGE  
NECESSARY  
IF MAILED  
IN THE  
UNITED STATES**

**BUSINESS REPLY MAIL**  
FIRST CLASS MAIL      PERMIT NO. 8      MT. MORRIS, IL

POSTAGE WILL BE PAID BY ADDRESSEE

**SOLDIER OF  
FORTUNE**

PO BOX 348

MT MORRIS IL 61054-9817

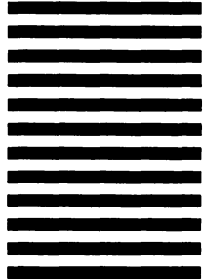

# STONER SR-25 RIFLE

## SUPER ACCURATE .308 MATCH CALIBER SEMI-AUTOMATIC

The **SR-25** is probably the most accurate and maintainable semi-automatic rifle which the author has fired, including match-quality M-14's.

Andrew C. Tillman,  
International Defense Review

Surely there must be a more satisfactory alternative to the M21. There wasn't, but there is now.

Peter G. Kokalis,  
Soldier of Fortune

We were all very impressed with the **SR-25 Match Rifle's** superb accuracy and performance.

Jim Benson,  
American Survival  
Guide

## The SR-25

is the most accurate .308 match caliber semi-automatic rifle available anywhere in the world today. It consistently and reliably shoots **SUB-MOA**.

- Precisely chambered, specially rifled, hammer forged carbon steel barrel.
- Free-floating, receiver-mounted, fiberglass handguard.
- Aircraft aluminum receiver assembly with hard anodized finish.
- Integral Picatinny/Weaver-style scope and handle mounting rail.
- 60% parts commonality with the AR15/M16.



### KNIGHT'S MANUFACTURING COMPANY

7750 9th Street S.W., Dept. SF  
Vero Beach, Florida 32968  
Phone: (407) 778-3700  
Fax: (407) 569-2955



### SUPER ACCURATE

Under 1 inch  
at 100 yards...  
round after round!

**5-SHOT GROUP**



1"



**ACTUAL TARGET AT 100 YARDS!**

For those who wonder if the **SR-25** can shoot even tighter groups than .98 inches, the answer is "YES."

Eric S. Kinchel, Gun World

Many don't think a semi-auto rifle can print bench-rest quality groups. They are wrong. Robert W. Hunnicutt,  
American Rifleman

**Quality scopes, scope rings,  
custom triggers, and other  
accessories also available.**